

# Type DCMC 85 °C High Capacitance, Screw Terminal, Aluminum

## Highest Capacitance Screw Terminal Type



With more capacitance and often more ripple-current capability than the best-value Type 3186 capacitor, the Type DCMC capacitor is the better choice for high-capacitance, power supply filters and energy storage applications such as welding equipment, UPS systems and computer hold-up power. The extended cathode foil of the DCMC assures cool operation with heatflow from the capacitor element to the can.

### Highlights

- Highest capacitance value
- Right for Power Supply and UPS systems
- Thermal-Pak™ extended cathode construction

### Specifications

|                                  |   |           |       |        |        |       |       |             |
|----------------------------------|---|-----------|-------|--------|--------|-------|-------|-------------|
| Temperature Range                | -40 °C to +85 °C  |           |       |        |        |       |       |             |
| Rated Voltage Range              | 6.3 Vdc to 550 Vdc  |           |       |        |        |       |       |             |
| Capacitance Range                | 110 µF to 2.7 F   |           |       |        |        |       |       |             |
| Capacitance Tolerance            | -10% +75% ≤ 100 Vdc<br>-10% +50% ≥ 160 Vdc  |           |       |        |        |       |       |             |
| Leakage Current                  | ≤ 6 $\sqrt{CV}$ µA, 6 mA max, at 5 min  |           |       |        |        |       |       |             |
| Ripple Current Multipliers       | Ambient Temperature   |           |       |        |        |       |       |             |
|                                  |   | 45 °C     | 55 °C | 65 °C  | 75 °C  | 85 °C |       |             |
|                                  |   | 2.24      | 2.00  | 1.73   | 1.41   | 1.00  |       |             |
|                                  |   | Frequency |       |        |        |       |       |             |
|                                  |   | 50 Hz     | 60 Hz | 120 Hz | 360 Hz | 1 kHz | 5 kHz | 10 kHz & up |
|                                  | <b>1 3/8" &amp; 1 3/4" Diameters</b>  |           |       |        |        |       |       |             |
|                                  | <b>6.3 to 160 V</b>   | 0.92      | 0.94  | 1.00   | 1.05   | 1.10  | 1.10  | 1.12        |
|                                  | <b>200 to 350 V</b>   | 0.80      | 0.85  | 1.00   | 1.17   | 1.30  | 1.30  | 1.32        |
|                                  | <b>400 to 550 V</b>   | 0.78      | 0.83  | 1.00   | 1.20   | 1.35  | 1.36  | 1.40        |
|                                  | <b>2" &amp; 2 1/2" Diameters</b>  |           |       |        |        |       |       |             |
| <b>6.3 to 160 V</b>              | 0.93  | 0.95      | 1.00  | 1.04   | 1.07   | 1.11  | 1.12  |             |
| <b>200 to 350 V</b>              | 0.81  | 0.87      | 1.00  | 1.13   | 1.20   | 1.24  | 1.26  |             |
| <b>400 to 550 V</b>              | 0.79  | 0.83      | 1.00  | 1.17   | 1.26   | 1.30  | 1.34  |             |
| <b>3" &amp; 3 1/2" Diameters</b> |   |           |       |        |        |       |       |             |
| <b>6.3 to 160 V</b>              | 0.95  | 0.96      | 1.00  | 1.02   | 1.04   | 1.05  | 1.05  |             |
| <b>200 to 350 V</b>              | 0.85  | 0.88      | 1.00  | 1.08   | 1.12   | 1.14  | 1.17  |             |
| <b>400 to 550 V</b>              | 0.82  | 0.84      | 1.00  | 1.13   | 1.20   | 1.24  | 1.27  |             |
| Low Temperature Characteristics  | Impedance ratio: $Z_{-20^{\circ}\text{C}}/Z_{+25^{\circ}\text{C}}$<br>≤ 20 (6.3–10 Vdc)<br>≤ 8 (16–50 Vdc)<br>≤ 4 (63–100 Vdc)<br>≤ 3 (150–550 Vdc) |           |       |        |        |       |       |             |
| Endurance Life Test              | 2000 h @ full load at 85 °C<br>Δ Capacitance ±20%<br>ESR 200% of limit<br>DCL 100% of limit   |           |       |        |        |       |       |             |
| Shelf Life Test                  | 500 h @ 85 °C<br>Capacitance 100% of limit<br>ESR 100% of limit<br>DCL 100% of limit  |           |       |        |        |       |       |             |
| Vibration                        | 5 to 55 Hz, 0.06" and 10 g max, 1.5 h each of 2 axes  |           |       |        |        |       |       |             |
| RoHS Compliant                   |   |           |       |        |        |       |       |             |

# Type DCMC 85 °C High Capacitance, Screw Terminal, Aluminum

## Highest Capacitance Screw Terminal Type

### Part Numbering System

|                           |                             |                       |                      |                  |                                   |                                    |                                  |
|---------------------------|-----------------------------|-----------------------|----------------------|------------------|-----------------------------------|------------------------------------|----------------------------------|
| <b>DCMC</b>               | <b>472</b>                  | <b>U</b>              | <b>400</b>           | <b>DC</b>        | <b>2</b>                          | <b>B</b>                           | <b>S</b>                         |
| <b>Type</b>               | <b>Capacitance</b>          | <b>Tolerance</b>      | <b>Voltage</b>       | <b>Case Code</b> | <b>Insulation</b>                 | <b>Terminal</b>                    | <b>Can Style</b>                 |
| <b>100</b> = 10 $\mu$ F   | <b>101</b> = 100 $\mu$ F    | <b>M</b> = $\pm 20\%$ | <b>6R3</b> = 6.3 Vdc | <b>0</b> = None  | <b>1</b> = Polyester              | <b>A</b> = Low Post                | <b>Blank</b> = Standard          |
| <b>492</b> = 4900 $\mu$ F | <b>433</b> = 43,000 $\mu$ F | <b>U</b> = -10%+75%   | <b>063</b> = 63 Vdc  | <b>2</b> = PVC   | <b>D</b> = High Current, Low Post | <b>E</b> = High Current, High Post | <b>S</b> = Stud Bottom           |
|                           |                             | <b>T</b> = -10%+50%   | <b>400</b> = 400 Vdc |                  |                                   | <b>F or M</b> = M5 Post            | <b>P</b> = Stud with Thermal Pad |
|                           |                             |                       |                      |                  |                                   | <b>G</b> = M6 Low Post             |                                  |
|                           |                             |                       |                      |                  |                                   | <b>H</b> = M6 High Post            |                                  |

Polyester insulation is not available for 3.5-inch diameter units.  
Standard insulation is 0.008-in PVC sleeve with 0.01-in polypropylene end disk.

### Outline Drawing

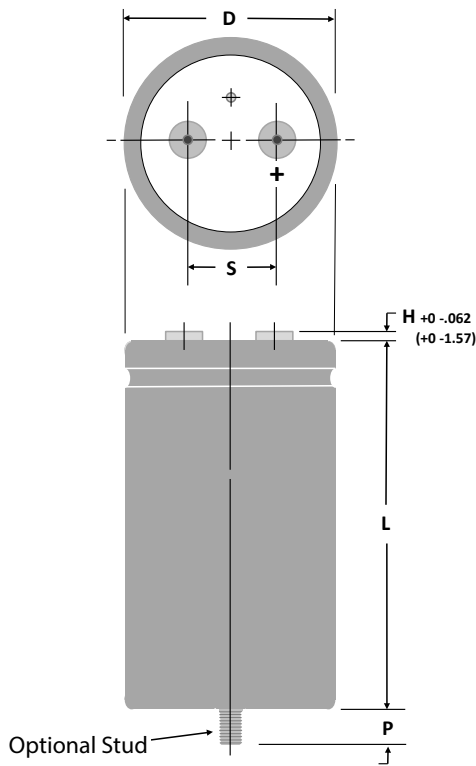

### Stud Dimensions

| Case Diam. | Stud Thread | P ± 0.039" (±1.0 mm) |
|------------|-------------|----------------------|
| 1.375      | M8          | 0.470" (12.0)        |
| 1.750      | M8          | 0.470" (12.0)        |
| 2.000      | M12         | 0.630" (16.0)        |
| 2.500      | M12         | 0.630" (16.0)        |
| 3.000      | M12         | 0.630" (16.0)        |
| 3.500      | M12         | 0.630" (16.0)        |

NOTE: With the stud-mount feature, a thermally-conductive disk can be inserted in the bottom flush with the outer insulating sleeve. This reduces the thermal resistance through the can bottom by 0.3 °C/W. Can Style P.

### Terminal Dimensions

| Terminal Style            | For Case       |      | Post Diameter |      | H max |     | Thread | min Full Thread |      | Torque |      |
|---------------------------|----------------|------|---------------|------|-------|-----|--------|-----------------|------|--------|------|
|                           | Diameters      | Code | in            | mm   | in    | mm  |        | in              | mm   | in-lb  | N-m  |
| <b>Low Post</b>           | 1 3/8 to 3     | A    | 0.314         | 8.0  | 0.094 | 2.4 | 10-32  | 0.218           | 5.5  | 25     | 2.82 |
| <b>High Post</b>          | 1 3/8 to 3     | B    | 0.314         | 8.0  | 0.281 | 7.1 | 10-32  | 0.375           | 9.5  | 25     | 2.82 |
| <b>High Current, Low</b>  | 2 1/2 to 3 1/2 | D    | 0.684         | 17.4 | 0.125 | 3.2 | 1/4-28 | 0.344           | 8.7  | 60     | 6.78 |
| <b>High Current, High</b> | 2 1/2 to 3 1/2 | E    | 0.684         | 17.4 | 0.281 | 7.1 | 1/4-28 | 0.469           | 11.9 | 60     | 6.78 |
| <b>M5 Post, Small</b>     | 1 3/8 to 2     | M    | 0.314         | 8.0  | 0.281 | 7.1 | M5     | 0.375           | 9.5  | 25     | 2.82 |
| <b>M5 Post</b>            | 2 1/2 & 3      | F    | 0.512         | 13.0 | 0.230 | 5.8 | M5     | 0.344           | 8.7  | 25     | 2.82 |
| <b>M6 Low Post</b>        | 2 1/2 to 3 1/2 | G    | 0.684         | 17.4 | 0.125 | 3.2 | M6     | 0.344           | 8.7  | 60     | 6.78 |
| <b>M6 High Post</b>       | 2 1/2 to 3 1/2 | H    | 0.684         | 17.4 | 0.281 | 7.1 | M6     | 0.469           | 11.9 | 60     | 6.78 |

NOTE: Only high post and M5 post terminals are available at 550 Vdc as they meet the required creepage distance.

# Type DCMC 85 °C High Capacitance, Screw Terminal, Aluminum

## Highest Capacitance Screw Terminal Type

### Uninsulated Case Dimensions

For insulated case, add 0.024"(0.610 mm) to "D" and 0.030"(0.762 mm) to height.

| Case Code | Diam. (D)    |         | Length (L)   |          | Terminals (S) |         | Typical Weight |        |
|-----------|--------------|---------|--------------|----------|---------------|---------|----------------|--------|
|           | ±.031 Inches | ±.78 mm | ±.062 Inches | ±1.57 mm | ±0.015 Inches | ±.38 mm | oz             | g      |
| AK        | 1.375        | 34.93   | 1.625        | 41.28    | 0.50          | 12.70   | 1.9            | 54     |
| AA        | 1.375        | 34.93   | 2.125        | 53.98    | 0.50          | 12.70   | 2.0            | 57     |
| AH        | 1.375        | 34.93   | 2.625        | 66.68    | 0.50          | 12.70   | 2.7            | 77     |
| AB        | 1.375        | 34.93   | 3.125        | 79.38    | 0.50          | 12.70   | 3.3            | 94     |
| AJ        | 1.375        | 34.93   | 3.625        | 92.08    | 0.50          | 12.70   | 3.8            | 108    |
| AC        | 1.375        | 34.93   | 4.125        | 104.78   | 0.50          | 12.70   | 4.4            | 125    |
| AD        | 1.375        | 34.93   | 4.625        | 117.48   | 0.50          | 12.70   | 5.1            | 145    |
| AE        | 1.375        | 34.93   | 5.125        | 130.18   | 0.50          | 12.70   | 6.8            | 193    |
| AF        | 1.375        | 34.93   | 5.625        | 142.88   | 0.50          | 12.70   | 8.1            | 230    |
| EA        | 1.750        | 44.45   | 2.125        | 53.98    | 0.75          | 19.05   | 2.7            | 76     |
| EH        | 1.750        | 44.45   | 2.625        | 66.68    | 0.75          | 19.05   | 3.8            | 108    |
| EB        | 1.750        | 44.45   | 3.125        | 79.38    | 0.75          | 19.05   | 5.1            | 145    |
| EJ        | 1.750        | 44.45   | 3.625        | 92.08    | 0.75          | 19.05   | 6.8            | 193    |
| EC        | 1.750        | 44.45   | 4.125        | 104.78   | 0.75          | 19.05   | 8.1            | 230    |
| ED        | 1.750        | 44.45   | 4.625        | 117.48   | 0.75          | 19.05   | 9.0            | 255    |
| EE        | 1.750        | 44.45   | 5.125        | 130.18   | 0.75          | 19.05   | 9.5            | 269    |
| EF        | 1.750        | 44.45   | 5.625        | 142.88   | 0.75          | 19.05   | 10.5           | 298    |
| BA        | 2.000        | 50.80   | 2.125        | 53.98    | 0.88          | 22.23   | 5.4            | 153    |
| BH        | 2.000        | 50.80   | 2.625        | 66.68    | 0.88          | 22.23   | 6.1            | 173    |
| BB        | 2.000        | 50.80   | 3.125        | 79.38    | 0.88          | 22.23   | 6.8            | 193    |
| BJ        | 2.000        | 50.80   | 3.625        | 92.08    | 0.88          | 22.23   | 8.2            | 232    |
| BC        | 2.000        | 50.80   | 4.125        | 104.78   | 0.88          | 22.23   | 9.5            | 269    |
| BD        | 2.000        | 50.80   | 4.625        | 117.48   | 0.88          | 22.23   | 10.3           | 292    |
| BE        | 2.000        | 50.80   | 5.125        | 130.18   | 0.88          | 22.23   | 10.7           | 303    |
| BF        | 2.000        | 50.80   | 5.625        | 142.88   | 0.88          | 22.23   | 13.0           | 369    |
| CH        | 2.500        | 63.50   | 2.625        | 66.68    | 1.13          | 28.58   | 9.2            | 261    |
| CB        | 2.500        | 63.50   | 3.125        | 79.38    | 1.13          | 28.58   | 10.4           | 295    |
| CJ        | 2.500        | 63.50   | 3.625        | 92.08    | 1.13          | 28.58   | 12.7           | 361    |
| CC        | 2.500        | 63.50   | 4.125        | 104.78   | 1.13          | 28.58   | 15.0           | 425    |
| CD        | 2.500        | 63.50   | 4.625        | 117.48   | 1.13          | 28.58   | 17.2           | 488    |
| CE        | 2.500        | 63.50   | 5.125        | 130.18   | 1.13          | 28.58   | 19.3           | 547    |
| CF        | 2.500        | 63.50   | 5.625        | 142.88   | 1.13          | 28.58   | 21.4           | 607    |
| DB        | 3.000        | 76.20   | 3.125        | 79.38    | 1.25          | 31.75   | 16.7           | 473    |
| DJ        | 3.000        | 76.20   | 3.625        | 92.08    | 1.25          | 31.75   | 20.0           | 567    |
| DC        | 3.000        | 76.20   | 4.125        | 104.78   | 1.25          | 31.75   | 22.2           | 629    |
| DD        | 3.000        | 76.20   | 4.625        | 117.48   | 1.25          | 31.75   | 25.5           | 723    |
| DE        | 3.000        | 76.20   | 5.125        | 130.18   | 1.25          | 31.75   | 30.0           | 850    |
| DF        | 3.000        | 76.20   | 5.625        | 142.88   | 1.25          | 31.75   | 31.9           | 904    |
| DM        | 3.000        | 76.20   | 6.625        | 168.28   | 1.25          | 31.75   | 34.4           | 933.5  |
| DP        | 3.000        | 76.20   | 5.875        | 149.23   | 1.25          | 31.75   | 32.8           | 931    |
| DN        | 3.000        | 76.20   | 7.625        | 193.68   | 1.25          | 31.75   | 39.5           | 1119   |
| DG        | 3.000        | 76.20   | 8.625        | 219.08   | 1.25          | 31.75   | 43.3           | 1227   |
| FC        | 3.500        | 88.90   | 4.125        | 104.78   | 1.25          | 31.75   | 30.0           | 850    |
| FD        | 3.500        | 88.90   | 4.625        | 117.48   | 1.25          | 31.75   | 34.4           | 976    |
| FE        | 3.500        | 88.90   | 5.125        | 130.18   | 1.25          | 31.75   | 40.5           | 1148   |
| FF        | 3.500        | 88.90   | 5.625        | 142.88   | 1.25          | 31.75   | 43.1           | 1221   |
| FP        | 3.500        | 88.90   | 5.875        | 149.23   | 1.25          | 31.75   | 44.3           | 1257   |
| FN        | 3.500        | 88.90   | 7.625        | 193.68   | 1.25          | 31.75   | 53.3           | 1512   |
| FG        | 3.500        | 88.90   | 8.625        | 219.08   | 1.25          | 31.75   | 58.5           | 1658   |
| FM        | 3.500        | 88.90   | 6.625        | 168.28   | 1.25          | 31.75   | 46.4           | 1315.4 |

# Type DCMC 85 °C High Capacitance, Screw Terminal, Aluminum

## Highest Capacitance Screw Terminal Type Ratings

| Cap. (µF)                    | Catalog Part Number | ESR Max. @ 25 °C 120 Hz (mΩ) | Ripple Max. @ 85°C 120 Hz (A) | Nominal Size D x L (inches) |
|------------------------------|---------------------|------------------------------|-------------------------------|-----------------------------|
| <b>6.3 Vdc (8 Vdc Surge)</b> |                     |                              |                               |                             |
| 28000                        | DCMC283U6R3AK2B     | 46.9                         | 4.1                           | 1 3/8 x 1 5/8               |
| 57000                        | DCMC573U6R3AA2B     | 26.5                         | 6.1                           | 1 3/8 x 2 1/8               |
| 68000                        | DCMC683U6R3AH2B     | 18.8                         | 7.8                           | 1 3/8 x 2 5/8               |
| 91000                        | DCMC913U6R3AB2B     | 14.7                         | 9.4                           | 1 3/8 x 3 1/8               |
| 100000                       | DCMC104U6R3EA2B     | 18.8                         | 8.8                           | 1 3/4 x 2 1/8               |
| 110000                       | DCMC114U6R3AJ2B     | 12.8                         | 11.2                          | 1 3/8 x 3 5/8               |
| 120000                       | DCMC124U6R3EH2B     | 14.3                         | 11.0                          | 1 3/4 x 2 5/8               |
| 130000                       | DCMC134U6R3AC2B     | 11.0                         | 13.0                          | 1 3/8 x 4 1/8               |
| 130000                       | DCMC134U6R3BA2B     | 14.2                         | 11.9                          | 2 x 2 1/8                   |
| 150000                       | DCMC154U6R3BH2B     | 9.9                          | 11.6                          | 2 x 2 5/8                   |
| 160000                       | DCMC164U6R3AD2B     | 9.8                          | 12.5                          | 1 3/8 x 4 5/8               |
| 160000                       | DCMC164U6R3EB2B     | 11.0                         | 12.6                          | 1 3/4 x 3 1/8               |
| 180000                       | DCMC184U6R3AE2B     | 8.9                          | 14.7                          | 1 3/8 x 5 1/8               |
| 200000                       | DCMC204U6R3AF2B     | 8.3                          | 16.0                          | 1 3/8 x 5 5/8               |
| 200000                       | DCMC204U6R3EJ2B     | 9.1                          | 15.9                          | 1 3/4 x 3 5/8               |
| 210000                       | DCMC214U6R3BB2B     | 7.8                          | 17.8                          | 2 x 3 1/8                   |
| 240000                       | DCMC244U6R3EC2B     | 7.9                          | 18.3                          | 1 3/4 x 4 1/8               |
| 260000                       | DCMC264U6R3BJ2B     | 6.5                          | 15.6                          | 2 x 3 5/8                   |
| 260000                       | DCMC264U6R3CH2B     | 6.9                          | 16.2                          | 2 1/2 x 2 5/8               |
| 280000                       | DCMC284U6R3ED2B     | 7.0                          | 17.1                          | 1 3/4 x 4 5/8               |
| 310000                       | DCMC314U6R3BC2B     | 5.6                          | 20.2                          | 2 x 4 1/8                   |
| 320000                       | DCMC324U6R3EE2B     | 6.4                          | 19.7                          | 1 3/4 x 5 1/8               |
| 350000                       | DCMC354U6R3CB2B     | 5.3                          | 22.6                          | 2 1/2 x 3 1/8               |
| 360000                       | DCMC364U6R3EF2B     | 6.0                          | 22.0                          | 1 3/4 x 5 5/8               |
| 370000                       | DCMC374U6R3BD2B     | 5.0                          | 24.9                          | 2 x 4 5/8                   |
| 420000                       | DCMC424U6R3BE2B     | 4.5                          | 23.0                          | 2 x 5 1/8                   |
| 440000                       | DCMC444U6R3CJ2B     | 4.3                          | 25.0                          | 2 1/2 x 3 5/8               |
| 470000                       | DCMC474U6R3BF2B     | 4.2                          | 26.7                          | 2 x 5 5/8                   |
| 520000                       | DCMC524U6R3DB2B     | 4.1                          | 28.3                          | 3 x 3 1/8                   |
| 530000                       | DCMC534U6R3CC2D     | 3.8                          | 30.4                          | 2 1/2 x 4 1/8               |
| 610000                       | DCMC614U6R3CD2D     | 3.4                          | 33.4                          | 2 1/2 x 4 5/8               |
| 650000                       | DCMC654U6R3DJ2D     | 3.3                          | 34.6                          | 3 x 3 5/8                   |
| 700000                       | DCMC704U6R3CE2D     | 3.1                          | 33.3                          | 2 1/2 x 5 1/8               |
| 780000                       | DCMC784U6R3DC2D     | 2.9                          | 35.7                          | 3 x 4 1/8                   |
| 790000                       | DCMC794U6R3CF2D     | 2.8                          | 37.9                          | 2 1/2 x 5 5/8               |
| 910000                       | DCMC914U6R3DD2D     | 2.6                          | 41.0                          | 3 x 4 5/8                   |
| 1000000                      | DCMC105U6R3DE2D     | 2.4                          | 44.4                          | 3 x 5 1/8                   |
| 1100000                      | DCMC115U6R3DF2D     | 2.4                          | 45.0                          | 3 x 5 5/8                   |
| 1100000                      | DCMC115U6R3FC2D     | 3.0                          | 41.4                          | 3 1/2 x 4 1/8               |
| 1200000                      | DCMC125U6R3DP2D     | 2.4                          | 51.5                          | 3 x 5 7/8                   |
| 1200000                      | DCMC125U6R3FD2D     | 2.6                          | 43.2                          | 3 1/2 x 4 5/8               |
| 1400000                      | DCMC145U6R3FE2D     | 2.4                          | 47.1                          | 3 1/2 x 5 1/8               |
| 1600000                      | DCMC165U6R3DN2D     | 2.4                          | 49.3                          | 3 x 7 5/8                   |
| 1600000                      | DCMC165U6R3FF2D     | 2.4                          | 47.9                          | 3 1/2 x 5 5/8               |
| 1700000                      | DCMC175U6R3FP2D     | 2.4                          | 49.4                          | 3 1/2 x 5 7/8               |
| 1900000                      | DCMC195U6R3DG2D     | 2.4                          | 49.9                          | 3 x 8 5/8                   |
| 2300000                      | DCMC235U6R3FN2D     | 2.4                          | 54.1                          | 3 1/2 x 7 5/8               |

| Cap. (µF)                    | Catalog Part Number | ESR Max. @ 25 °C 120 Hz (mΩ) | Ripple Max. @ 85°C 120 Hz (A) | Nominal Size D x L (inches) |
|------------------------------|---------------------|------------------------------|-------------------------------|-----------------------------|
| 2700000                      | DCMC275U6R3FG2D     | 2.4                          | 56.5                          | 3 1/2 x 8 5/8               |
| <b>10 Vdc (12 Vdc Surge)</b> |                     |                              |                               |                             |
| 24000                        | DCMC243U010AK2B     | 46.9                         | 4.1                           | 1 3/8 x 1 5/8               |
| 44000                        | DCMC443U010AA2B     | 26.5                         | 6.1                           | 1 3/8 x 2 1/8               |
| 57000                        | DCMC573U010AH2B     | 20.1                         | 7.5                           | 1 3/8 x 2 5/8               |
| 76000                        | DCMC763U010AB2B     | 15.5                         | 9.2                           | 1 3/8 x 3 1/8               |
| 79000                        | DCMC793U010EA2B     | 18.8                         | 8.8                           | 1 3/4 x 2 1/8               |
| 96000                        | DCMC963U010AJ2B     | 12.8                         | 11.2                          | 1 3/8 x 3 5/8               |
| 100000                       | DCMC104U010EH2B     | 14.3                         | 11.0                          | 1 3/4 x 2 5/8               |
| 100000                       | DCMC104U010BA2B     | 17.6                         | 10.3                          | 2 x 2 1/8                   |
| 110000                       | DCMC114U010AC2B     | 11.0                         | 13.5                          | 1 3/8 x 4 1/8               |
| 130000                       | DCMC134U010AD2B     | 9.8                          | 11.6                          | 1 3/8 x 4 5/8               |
| 140000                       | DCMC144U010EB2B     | 11.0                         | 11.8                          | 1 3/4 x 3 1/8               |
| 140000                       | DCMC144U010BH2B     | 13.4                         | 11.4                          | 2 x 2 5/8                   |
| 150000                       | DCMC154U010AE2B     | 8.9                          | 14.7                          | 1 3/8 x 5 1/8               |
| 170000                       | DCMC174U010AF2B     | 8.3                          | 16.0                          | 1 3/8 x 5 5/8               |
| 170000                       | DCMC174U010EJ2B     | 9.1                          | 15.9                          | 1 3/4 x 3 5/8               |
| 180000                       | DCMC184U010BB2B     | 10.5                         | 15.4                          | 2 x 3 1/8                   |
| 210000                       | DCMC214U010EC2B     | 7.9                          | 18.3                          | 1 3/4 x 4 1/8               |
| 220000                       | DCMC224U010BJ2B     | 8.7                          | 13.5                          | 2 x 3 5/8                   |
| 220000                       | DCMC224U010CH2B     | 8.8                          | 14.4                          | 2 1/2 x 2 5/8               |
| 240000                       | DCMC244U010ED2B     | 7.0                          | 17.1                          | 1 3/4 x 4 5/8               |
| 270000                       | DCMC274U010BC2B     | 7.5                          | 17.4                          | 2 x 4 1/8                   |
| 280000                       | DCMC284U010EE2B     | 6.4                          | 19.7                          | 1 3/4 x 5 1/8               |
| 290000                       | DCMC294U010CB2B     | 6.7                          | 20.0                          | 2 1/2 x 3 1/8               |
| 310000                       | DCMC314U010EF2B     | 6.0                          | 22.0                          | 1 3/4 x 5 5/8               |
| 310000                       | DCMC314U010BD2B     | 6.7                          | 21.5                          | 2 x 4 5/8                   |
| 350000                       | DCMC354U010BE2B     | 6.1                          | 19.8                          | 2 x 5 1/8                   |
| 370000                       | DCMC374U010CJ2B     | 5.5                          | 22.1                          | 2 1/2 x 3 5/8               |
| 400000                       | DCMC404U010BF2B     | 5.7                          | 22.9                          | 2 x 5 5/8                   |
| 430000                       | DCMC434U010DB2B     | 4.1                          | 28.3                          | 3 x 3 1/8                   |
| 440000                       | DCMC444U010CC2B     | 4.8                          | 26.9                          | 2 1/2 x 4 1/8               |
| 510000                       | DCMC514U010CD2B     | 4.3                          | 29.5                          | 2 1/2 x 4 5/8               |
| 540000                       | DCMC544U010DJ2D     | 3.3                          | 34.6                          | 3 x 3 5/8                   |
| 590000                       | DCMC594U010CE2B     | 3.9                          | 29.5                          | 2 1/2 x 5 1/8               |
| 640000                       | DCMC644U010DC2D     | 2.9                          | 35.7                          | 3 x 4 1/8                   |
| 660000                       | DCMC664U010CF2D     | 3.6                          | 33.5                          | 2 1/2 x 5 5/8               |
| 750000                       | DCMC754U010DD2D     | 2.6                          | 41.0                          | 3 x 4 5/8                   |
| 860000                       | DCMC864U010DE2D     | 2.4                          | 44.4                          | 3 x 5 1/8                   |
| 900000                       | DCMC904U010FC2D     | 2.9                          | 41.6                          | 3 1/2 x 4 1/8               |
| 940000                       | DCMC944U010DF2D     | 2.3                          | 47.1                          | 3 x 5 5/8                   |
| 1000000                      | DCMC105U010DP2D     | 2.3                          | 52.8                          | 3 x 5 7/8                   |
| 1000000                      | DCMC105U010FD2D     | 2.8                          | 42.0                          | 3 1/2 x 4 5/8               |
| 1200000                      | DCMC125U010FE2D     | 2.5                          | 46.3                          | 3 1/2 x 5 1/8               |
| 1300000                      | DCMC135U010FF2D     | 2.2                          | 50.3                          | 3 1/2 x 5 5/8               |
| 1400000                      | DCMC145U010DN2D     | 2.1                          | 52.7                          | 3 x 7 5/8                   |
| 1400000                      | DCMC145U010FP2D     | 2.1                          | 52.7                          | 3 1/2 x 5 7/8               |
| 1600000                      | DCMC165U010DG2D     | 2.1                          | 54.2                          | 3 x 8 5/8                   |

# Type DCMC 85 °C High Capacitance, Screw Terminal, Aluminum

## Highest Capacitance Screw Terminal Type

| Cap. (µF)                    | Catalog Part Number | ESR Max. @ 25 °C 120 Hz (mΩ) | Ripple Max. @ 85°C 120 Hz (A) | Nominal Size D x L (inches) |
|------------------------------|---------------------|------------------------------|-------------------------------|-----------------------------|
| 1900000                      | DCMC195U010FN2D     | 1.8                          | 64.3                          | 3 1/2 x 7 5/8               |
| 2200000                      | DCMC225U010FG2D     | 1.5                          | 70.6                          | 3 1/2 x 8 5/8               |
| <b>16 Vdc (20 Vdc Surge)</b> |                     |                              |                               |                             |
| 21000                        | DCMC213U016AK2B     | 46.9                         | 4.1                           | 1 3/8 x 1 5/8               |
| 35000                        | DCMC353U016AA2B     | 26.5                         | 6.1                           | 1 3/8 x 2 1/8               |
| 49000                        | DCMC493U016AH2B     | 20.1                         | 7.5                           | 1 3/8 x 2 5/8               |
| 57000                        | DCMC573U016EA2B     | 18.8                         | 8.3                           | 1 3/4 x 2 1/8               |
| 62000                        | DCMC623U016AB2B     | 15.5                         | 9.7                           | 1 3/8 x 3 1/8               |
| 73000                        | DCMC733U016BA2B     | 17.6                         | 9.5                           | 2 x 2 1/8                   |
| 76000                        | DCMC763U016AJ2B     | 12.8                         | 11.7                          | 1 3/8 x 3 5/8               |
| 77000                        | DCMC773U016EH2B     | 15.3                         | 11.1                          | 1 3/4 x 2 5/8               |
| 90000                        | DCMC903U016AC2B     | 11.0                         | 13.5                          | 1 3/8 x 4 1/8               |
| 99000                        | DCMC993U016AD2B     | 9.8                          | 11.6                          | 1 3/8 x 4 5/8               |
| 100000                       | DCMC104U016EB2B     | 12.5                         | 11.1                          | 1 3/4 x 3 1/8               |
| 110000                       | DCMC114U016AE2B     | 8.9                          | 14.0                          | 1 3/8 x 5 1/8               |
| 110000                       | DCMC114U016BH2B     | 13.4                         | 12.0                          | 2 x 2 5/8                   |
| 130000                       | DCMC134U016AF2B     | 8.3                          | 16.0                          | 1 3/8 x 5 5/8               |
| 130000                       | DCMC134U016EJ2B     | 10.9                         | 14.6                          | 1 3/4 x 3 5/8               |
| 130000                       | DCMC134U016BB2B     | 10.5                         | 15.4                          | 2 x 3 1/8                   |
| 150000                       | DCMC154U016EC2B     | 9.7                          | 16.5                          | 1 3/4 x 4 1/8               |
| 160000                       | DCMC164U016BJ2B     | 8.7                          | 13.5                          | 2 x 3 5/8                   |
| 160000                       | DCMC164U016CH2B     | 8.8                          | 14.4                          | 2 1/2 x 2 5/8               |
| 180000                       | DCMC184U016ED2B     | 8.8                          | 15.3                          | 1 3/4 x 4 5/8               |
| 200000                       | DCMC204U016BC2B     | 7.5                          | 17.4                          | 2 x 4 1/8                   |
| 210000                       | DCMC214U016EE2B     | 8.2                          | 17.5                          | 1 3/4 x 5 1/8               |
| 220000                       | DCMC224U016CB2B     | 6.7                          | 20.0                          | 2 1/2 x 3 1/8               |
| 230000                       | DCMC234U016EF2B     | 7.8                          | 19.3                          | 1 3/4 x 5 5/8               |
| 230000                       | DCMC234U016BD2B     | 6.7                          | 21.5                          | 2 x 4 5/8                   |
| 260000                       | DCMC264U016BE2B     | 6.1                          | 19.8                          | 2 x 5 1/8                   |
| 270000                       | DCMC274U016CJ2B     | 5.5                          | 22.1                          | 2 1/2 x 3 5/8               |
| 290000                       | DCMC294U016BF2B     | 5.7                          | 22.9                          | 2 x 5 5/8                   |
| 320000                       | DCMC324U016CC2B     | 5.0                          | 25.6                          | 2 1/2 x 4 1/8               |
| 320000                       | DCMC324U016DB2B     | 4.2                          | 28.9                          | 3 x 3 1/8                   |
| 380000                       | DCMC384U016CD2B     | 4.6                          | 28.5                          | 2 1/2 x 4 5/8               |
| 400000                       | DCMC404U016DJ2D     | 3.6                          | 33.3                          | 3 x 3 5/8                   |
| 430000                       | DCMC434U016CE2B     | 4.4                          | 27.9                          | 2 1/2 x 5 1/8               |
| 480000                       | DCMC484U016DC2D     | 3.3                          | 33.8                          | 3 x 4 1/8                   |
| 490000                       | DCMC494U016CF2D     | 4.2                          | 31.2                          | 2 1/2 x 5 5/8               |
| 560000                       | DCMC564U016DD2D     | 3.1                          | 37.5                          | 3 x 4 5/8                   |
| 650000                       | DCMC654U016DE2D     | 2.8                          | 40.5                          | 3 x 5 1/8                   |
| 700000                       | DCMC704U016FC2D     | 2.9                          | 41.6                          | 3 1/2 x 4 1/8               |
| 710000                       | DCMC714U016DF2D     | 2.8                          | 42.8                          | 3 x 5 5/8                   |
| 750000                       | DCMC754U016DP2D     | 2.8                          | 48.3                          | 3 x 5 7/8                   |
| 810000                       | DCMC814U016FD2D     | 2.8                          | 42.1                          | 3 1/2 x 4 5/8               |
| 930000                       | DCMC934U016FE2D     | 2.5                          | 46.2                          | 3 1/2 x 5 1/8               |
| 1000000                      | DCMC105U016FF2D     | 2.4                          | 48.3                          | 3 1/2 x 5 5/8               |
| 1000000                      | DCMC105U016DN2D     | 2.6                          | 47.5                          | 3 x 7 5/8                   |
| 1500000                      | DCMC155U016FN2D     | 2.3                          | 55.4                          | 3 1/2 x 7 5/8               |

| Cap. (µF)                    | Catalog Part Number | ESR Max. @ 25 °C 120 Hz (mΩ) | Ripple Max. @ 85°C 120 Hz (A) | Nominal Size D x L (inches) |
|------------------------------|---------------------|------------------------------|-------------------------------|-----------------------------|
| 1700000                      | DCMC175U016FG2D     | 2.3                          | 58.2                          | 3 1/2 x 8 5/8               |
| <b>25 Vdc (30 Vdc Surge)</b> |                     |                              |                               |                             |
| 12000                        | DCMC123U025AK2B     | 37.1                         | 4.7                           | 1 3/8 x 1 5/8               |
| 20000                        | DCMC203U025AA2B     | 23.6                         | 6.5                           | 1 3/8 x 2 1/8               |
| 24000                        | DCMC243U025AH2B     | 20.1                         | 7.5                           | 1 3/8 x 2 5/8               |
| 33000                        | DCMC333U025AB2B     | 19.3                         | 8.2                           | 1 3/8 x 3 1/8               |
| 36000                        | DCMC363U025EA2B     | 21.8                         | 8.2                           | 1 3/4 x 2 1/8               |
| 42000                        | DCMC423U025AJ2B     | 19.4                         | 9.1                           | 1 3/8 x 3 5/8               |
| 43000                        | DCMC433U025EH2B     | 19.4                         | 9.5                           | 1 3/4 x 2 5/8               |
| 47000                        | DCMC473U025BA2B     | 21.8                         | 9.3                           | 2 x 2 1/8                   |
| 52000                        | DCMC523U025AC2B     | 17.6                         | 10.7                          | 1 3/8 x 4 1/8               |
| 59000                        | DCMC593U025BH2B     | 16.5                         | 9.0                           | 2 x 2 5/8                   |
| 60000                        | DCMC603U025EB2B     | 15.2                         | 10.1                          | 1 3/4 x 3 1/8               |
| 61000                        | DCMC613U025AD2B     | 16.4                         | 10.3                          | 1 3/8 x 4 5/8               |
| 71000                        | DCMC713U025AE2B     | 15.2                         | 11.3                          | 1 3/8 x 5 1/8               |
| 76000                        | DCMC763U025BB2B     | 12.2                         | 13.2                          | 2 x 3 1/8                   |
| 77000                        | DCMC773U025EJ2B     | 12.8                         | 13.4                          | 1 3/4 x 3 5/8               |
| 80000                        | DCMC803U025AF2B     | 14.0                         | 13.3                          | 1 3/8 x 5 5/8               |
| 90000                        | DCMC903U025CH2B     | 9.5                          | 16.7                          | 2 1/2 x 2 5/8               |
| 94000                        | DCMC943U025EC2B     | 11.2                         | 11.8                          | 1 3/4 x 4 1/8               |
| 98000                        | DCMC983U025BJ2B     | 9.8                          | 13.6                          | 2 x 3 5/8                   |
| 110000                       | DCMC114U025ED2B     | 10.2                         | 14.2                          | 1 3/4 x 4 5/8               |
| 120000                       | DCMC124U025BC2B     | 8.3                          | 16.6                          | 2 x 4 1/8                   |
| 130000                       | DCMC134U025EE2B     | 9.6                          | 16.1                          | 1 3/4 x 5 1/8               |
| 130000                       | DCMC134U025CB2B     | 7.6                          | 18.9                          | 2 1/2 x 3 1/8               |
| 140000                       | DCMC144U025BD2B     | 7.3                          | 19.9                          | 2 x 4 5/8                   |
| 150000                       | DCMC154U025EF2B     | 9.1                          | 18.4                          | 1 3/4 x 5 5/8               |
| 160000                       | DCMC164U025BE2B     | 6.6                          | 19.1                          | 2 x 5 1/8                   |
| 160000                       | DCMC164U025CJ2B     | 6.4                          | 20.5                          | 2 1/2 x 3 5/8               |
| 190000                       | DCMC194U025BF2B     | 6.1                          | 22.2                          | 2 x 5 5/8                   |
| 190000                       | DCMC194U025DB2B     | 5.0                          | 25.5                          | 3 x 3 1/8                   |
| 200000                       | DCMC204U025CC2B     | 5.8                          | 24.6                          | 2 1/2 x 4 1/8               |
| 230000                       | DCMC234U025CD2B     | 5.2                          | 26.8                          | 2 1/2 x 4 5/8               |
| 240000                       | DCMC244U025DJ2D     | 4.3                          | 30.5                          | 3 x 3 5/8                   |
| 270000                       | DCMC274U025CE2B     | 5.0                          | 26.0                          | 2 1/2 x 5 1/8               |
| 300000                       | DCMC304U025DC2D     | 3.9                          | 31.0                          | 3 x 4 1/8                   |
| 310000                       | DCMC314U025CF2B     | 4.6                          | 29.8                          | 2 1/2 x 5 5/8               |
| 350000                       | DCMC354U025DD2D     | 3.5                          | 35.1                          | 3 x 4 5/8                   |
| 400000                       | DCMC404U025DE2D     | 3.3                          | 37.5                          | 3 x 5 1/8                   |
| 430000                       | DCMC434U025FC2D     | 3.8                          | 36.0                          | 3 1/2 x 4 1/8               |
| 460000                       | DCMC464U025DF2D     | 3.2                          | 39.9                          | 3 x 5 5/8                   |
| 490000                       | DCMC494U025DP2D     | 3.1                          | 46.0                          | 3 x 5 7/8                   |
| 500000                       | DCMC504U025FD2D     | 3.5                          | 37.6                          | 3 1/2 x 4 5/8               |
| 580000                       | DCMC584U025FE2D     | 3.2                          | 40.3                          | 3 1/2 x 5 1/8               |
| 660000                       | DCMC664U025FF2D     | 3.1                          | 42.8                          | 3 1/2 x 5 5/8               |
| 670000                       | DCMC674U025DN2D     | 3.1                          | 44.0                          | 3 x 7 5/8                   |
| 700000                       | DCMC704U025FP2D     | 2.9                          | 44.9                          | 3 1/2 x 5 7/8               |
| 780000                       | DCMC784U025DG2D     | 3.0                          | 44.9                          | 3 x 8 5/8                   |

# Type DCMC 85 °C High Capacitance, Screw Terminal, Aluminum

## Highest Capacitance Screw Terminal Type

| Cap. (µF)                    | Catalog Part Number | ESR Max. @ 25 °C 120 Hz (mΩ) | Ripple Max. @ 85°C 120 Hz (A) | Nominal Size D x L (inches) |
|------------------------------|---------------------|------------------------------|-------------------------------|-----------------------------|
| 950000                       | DCMC954U025FN2D     | 3.0                          | 48.7                          | 3 1/2 x 7 5/8               |
| 1100000                      | DCMC115U025FG2D     | 2.9                          | 51.1                          | 3 1/2 x 8 5/8               |
| <b>35 Vdc (40 Vdc Surge)</b> |                     |                              |                               |                             |
| 8200                         | DCMC822U035AK2B     | 41.7                         | 4.4                           | 1 3/8 x 1 5/8               |
| 14000                        | DCMC143U035AA2B     | 26.7                         | 6.1                           | 1 3/8 x 2 1/8               |
| 16000                        | DCMC163U035AH2B     | 23.2                         | 7.0                           | 1 3/8 x 2 5/8               |
| 23000                        | DCMC233U035AB2B     | 21.9                         | 7.7                           | 1 3/8 x 3 1/8               |
| 25000                        | DCMC253U035EA2B     | 22.3                         | 8.1                           | 1 3/4 x 2 1/8               |
| 30000                        | DCMC303U035AJ2B     | 21.6                         | 8.6                           | 1 3/8 x 3 5/8               |
| 30000                        | DCMC303U035EH2B     | 19.2                         | 9.5                           | 1 3/4 x 2 5/8               |
| 32000                        | DCMC323U035BA2B     | 24.5                         | 8.8                           | 2 x 2 1/8                   |
| 36000                        | DCMC363U035AC2B     | 20.1                         | 10.0                          | 1 3/8 x 4 1/8               |
| 41000                        | DCMC413U035BH2B     | 20.1                         | 8.1                           | 2 x 2 5/8                   |
| 42000                        | DCMC423U035EB2B     | 15.5                         | 10.0                          | 1 3/4 x 3 1/8               |
| 43000                        | DCMC433U035AD2B     | 17.8                         | 9.9                           | 1 3/8 x 4 5/8               |
| 49000                        | DCMC493U035AE2B     | 15.5                         | 11.2                          | 1 3/8 x 5 1/8               |
| 53000                        | DCMC533U035BB2B     | 15.9                         | 11.6                          | 2 x 3 1/8                   |
| 54000                        | DCMC543U035EJ2B     | 13.2                         | 13.2                          | 1 3/4 x 3 5/8               |
| 56000                        | DCMC563U035AF2B     | 14.1                         | 13.3                          | 1 3/8 x 5 5/8               |
| 63000                        | DCMC633U035CH2B     | 14.8                         | 13.4                          | 2 1/2 x 2 5/8               |
| 66000                        | DCMC663U035EC2B     | 11.8                         | 11.5                          | 1 3/4 x 4 1/8               |
| 69000                        | DCMC693U035BJ2B     | 13.2                         | 11.7                          | 2 x 3 5/8                   |
| 78000                        | DCMC783U035ED2B     | 10.6                         | 13.9                          | 1 3/4 x 4 5/8               |
| 84000                        | DCMC843U035BC2B     | 11.6                         | 14.0                          | 2 x 4 1/8                   |
| 88000                        | DCMC883U035CB2B     | 11.5                         | 14.7                          | 2 1/2 x 3 1/8               |
| 90000                        | DCMC903U035EE2B     | 9.8                          | 16.6                          | 1 3/4 x 5 1/8               |
| 99000                        | DCMC993U035BD2B     | 10.5                         | 16.6                          | 2 x 4 5/8                   |
| 100000                       | DCMC104U035EF2B     | 9.4                          | 18.1                          | 1 3/4 x 5 5/8               |
| 110000                       | DCMC114U035BE2B     | 9.8                          | 15.6                          | 2 x 5 1/8                   |
| 110000                       | DCMC114U035CJ2B     | 9.4                          | 16.9                          | 2 1/2 x 3 5/8               |
| 130000                       | DCMC134U035BF2B     | 9.4                          | 17.9                          | 2 x 5 5/8                   |
| 130000                       | DCMC134U035DB2B     | 6.9                          | 21.8                          | 3 x 3 1/8                   |
| 140000                       | DCMC144U035CC2B     | 8.2                          | 20.6                          | 2 1/2 x 4 1/8               |
| 160000                       | DCMC164U035CD2B     | 7.4                          | 22.5                          | 2 1/2 x 4 5/8               |
| 170000                       | DCMC174U035DJ2B     | 5.7                          | 26.4                          | 3 x 3 5/8                   |
| 190000                       | DCMC194U035CE2B     | 6.8                          | 22.3                          | 2 1/2 x 5 1/8               |
| 210000                       | DCMC214U035CF2B     | 6.1                          | 24.7                          | 2 1/2 x 5 5/8               |
| 210000                       | DCMC214U035DC2B     | 5.2                          | 28.0                          | 3 x 4 1/8                   |
| 240000                       | DCMC244U035DD2D     | 4.7                          | 30.5                          | 3 x 4 5/8                   |
| 280000                       | DCMC284U035DE2D     | 4.4                          | 32.6                          | 3 x 5 1/8                   |
| 300000                       | DCMC304U035FC2D     | 4.9                          | 31.7                          | 3 1/2 x 4 1/8               |
| 320000                       | DCMC324U035DF2D     | 4.0                          | 35.5                          | 3 x 5 5/8                   |
| 340000                       | DCMC344U035DP2D     | 3.9                          | 40.9                          | 3 x 5 7/8                   |
| 350000                       | DCMC354U035FD2D     | 4.5                          | 33.0                          | 3 1/2 x 4 5/8               |
| 410000                       | DCMC414U035FE2D     | 4.0                          | 36.2                          | 3 1/2 x 5 1/8               |
| 460000                       | DCMC464U035FF2D     | 3.6                          | 39.2                          | 3 1/2 x 5 5/8               |
| 470000                       | DCMC474U035DN2D     | 3.8                          | 39.8                          | 3 x 7 5/8                   |
| 490000                       | DCMC494U035FP2D     | 3.5                          | 41.1                          | 3 1/2 x 5 7/8               |

| Cap. (µF)                    | Catalog Part Number | ESR Max. @ 25 °C 120 Hz (mΩ) | Ripple Max. @ 85°C 120 Hz (A) | Nominal Size D x L (inches) |
|------------------------------|---------------------|------------------------------|-------------------------------|-----------------------------|
| 550000                       | DCMC554U035DG2D     | 3.6                          | 40.9                          | 3 x 8 5/8                   |
| 680000                       | DCMC684U035FN2D     | 3.4                          | 45.7                          | 3 1/2 x 7 5/8               |
| 790000                       | DCMC794U035FG2D     | 3.3                          | 48.4                          | 3 1/2 x 8 5/8               |
| <b>50 Vdc (65 Vdc Surge)</b> |                     |                              |                               |                             |
| 5900                         | DCMC592U050AK2B     | 47.9                         | 4.1                           | 1 3/8 x 1 5/8               |
| 10000                        | DCMC103U050AA2B     | 30.9                         | 5.6                           | 1 3/8 x 2 1/8               |
| 12000                        | DCMC123U050AH2B     | 25.9                         | 6.7                           | 1 3/8 x 2 5/8               |
| 16000                        | DCMC163U050AB2B     | 23.6                         | 7.4                           | 1 3/8 x 3 1/8               |
| 18000                        | DCMC183U050EA2B     | 22.8                         | 8.0                           | 1 3/4 x 2 1/8               |
| 21000                        | DCMC213U050AJ2B     | 19.6                         | 9.0                           | 1 3/8 x 3 5/8               |
| 21000                        | DCMC213U050EH2B     | 20.2                         | 9.3                           | 1 3/4 x 2 5/8               |
| 23000                        | DCMC233U050BA2B     | 25.3                         | 8.6                           | 2 x 2 1/8                   |
| 26000                        | DCMC263U050AC2B     | 18.7                         | 10.4                          | 1 3/8 x 4 1/8               |
| 29000                        | DCMC293U050BH2B     | 20.8                         | 8.0                           | 2 x 2 5/8                   |
| 30000                        | DCMC303U050EB2B     | 15.6                         | 9.9                           | 1 3/4 x 3 1/8               |
| 31000                        | DCMC313U050AD2B     | 17.9                         | 9.9                           | 1 3/8 x 4 5/8               |
| 35000                        | DCMC353U050AE2B     | 15.9                         | 11.0                          | 1 3/8 x 5 1/8               |
| 38000                        | DCMC383U050EJ2B     | 13.5                         | 12.5                          | 1 3/4 x 3 5/8               |
| 38000                        | DCMC383U050BB2B     | 16.3                         | 11.9                          | 2 x 3 1/8                   |
| 40000                        | DCMC403U050AF2B     | 14.4                         | 13.1                          | 1 3/8 x 5 5/8               |
| 45000                        | DCMC453U050CH2B     | 15.1                         | 13.3                          | 2 1/2 x 2 5/8               |
| 47000                        | DCMC473U050EC2B     | 12.0                         | 11.4                          | 1 3/4 x 4 1/8               |
| 49000                        | DCMC493U050BJ2B     | 13.6                         | 11.6                          | 2 x 3 5/8                   |
| 56000                        | DCMC563U050ED2B     | 10.8                         | 13.8                          | 1 3/4 x 4 5/8               |
| 60000                        | DCMC603U050BC2B     | 11.9                         | 13.8                          | 2 x 4 1/8                   |
| 63000                        | DCMC633U050CB2B     | 12.0                         | 14.4                          | 2 1/2 x 3 1/8               |
| 64000                        | DCMC643U050EE2B     | 9.8                          | 16.6                          | 1 3/4 x 5 1/8               |
| 71000                        | DCMC713U050BD2B     | 10.8                         | 16.4                          | 2 x 4 5/8                   |
| 73000                        | DCMC733U050EF2B     | 9.5                          | 18.0                          | 1 3/4 x 5 5/8               |
| 81000                        | DCMC813U050CJ2B     | 10.3                         | 15.2                          | 2 1/2 x 3 5/8               |
| 82000                        | DCMC823U050BE2B     | 10.0                         | 16.4                          | 2 x 5 1/8                   |
| 93000                        | DCMC933U050BF2B     | 9.5                          | 17.7                          | 2 x 5 5/8                   |
| 94000                        | DCMC943U050DB2B     | 9.1                          | 18.9                          | 3 x 3 1/8                   |
| 99000                        | DCMC993U050CC2B     | 8.9                          | 19.8                          | 2 1/2 x 4 1/8               |
| 120000                       | DCMC124U050CD2B     | 7.9                          | 21.8                          | 2 1/2 x 4 5/8               |
| 120000                       | DCMC124U050DJ2B     | 7.7                          | 22.7                          | 3 x 3 5/8                   |
| 130000                       | DCMC134U050CE2B     | 7.2                          | 21.7                          | 2 1/2 x 5 1/8               |
| 150000                       | DCMC154U050CF2B     | 6.7                          | 23.7                          | 2 1/2 x 5 5/8               |
| 150000                       | DCMC154U050DC2B     | 6.9                          | 24.2                          | 3 x 4 1/8                   |
| 170000                       | DCMC174U050DD2B     | 6.1                          | 26.7                          | 3 x 4 5/8                   |
| 200000                       | DCMC204U050DE2B     | 5.9                          | 28.1                          | 3 x 5 1/8                   |
| 200000                       | DCMC204U050FC2D     | 6.4                          | 27.9                          | 3 1/2 x 4 1/8               |
| 230000                       | DCMC234U050DF2D     | 5.6                          | 30.0                          | 3 x 5 5/8                   |
| 230000                       | DCMC234U050FD2D     | 5.7                          | 33.8                          | 3 1/2 x 4 5/8               |
| 240000                       | DCMC244U050DP2D     | 5.4                          | 30.2                          | 3 x 5 7/8                   |
| 270000                       | DCMC274U050FE2D     | 5.4                          | 31.3                          | 3 1/2 x 5 1/8               |
| 310000                       | DCMC314U050FF2D     | 5.1                          | 33.2                          | 3 1/2 x 5 5/8               |
| 320000                       | DCMC324U050FP2D     | 4.9                          | 34.8                          | 3 1/2 x 5 7/8               |

# Type DCMC 85 °C High Capacitance, Screw Terminal, Aluminum

## Highest Capacitance Screw Terminal Type

| Cap. (µF)                    | Catalog Part Number | ESR Max. @ 25 °C 120 Hz (mΩ) | Ripple Max. @ 85°C 120 Hz (A) | Nominal Size D x L (inches) |
|------------------------------|---------------------|------------------------------|-------------------------------|-----------------------------|
| 350000                       | DCMC354U050DN2D     | 4.5                          | 37.5                          | 3 x 7 5/8                   |
| 390000                       | DCMC394U050DG2D     | 4.1                          | 38.6                          | 3 x 8 5/8                   |
| 450000                       | DCMC454U050FN2D     | 4.2                          | 41.3                          | 3 1/2 x 7 5/8               |
| 520000                       | DCMC524U050FG2D     | 3.8                          | 44.9                          | 3 1/2 x 8 5/8               |
| <b>63 Vdc (75 Vdc Surge)</b> |                     |                              |                               |                             |
| 4100                         | DCMC412U063AK2B     | 60.6                         | 3.6                           | 1 3/8 x 1 5/8               |
| 7000                         | DCMC702U063AA2B     | 39.0                         | 5.0                           | 1 3/8 x 2 1/8               |
| 8300                         | DCMC832U063AH2B     | 32.7                         | 5.9                           | 1 3/8 x 2 5/8               |
| 12000                        | DCMC123U063AB2B     | 28.6                         | 6.8                           | 1 3/8 x 3 1/8               |
| 13000                        | DCMC133U063EA2B     | 27.9                         | 7.2                           | 1 3/4 x 2 1/8               |
| 15000                        | DCMC153U063AJ2B     | 26.1                         | 7.8                           | 1 3/8 x 3 5/8               |
| 15000                        | DCMC153U063EH2B     | 25.6                         | 8.2                           | 1 3/4 x 2 5/8               |
| 15000                        | DCMC153U063BA2B     | 28.0                         | 8.2                           | 2 x 2 1/8                   |
| 18000                        | DCMC183U063AC2B     | 22.0                         | 9.6                           | 1 3/8 x 4 1/8               |
| 18000                        | DCMC183U063BH2B     | 22.6                         | 7.7                           | 2 x 2 5/8                   |
| 21000                        | DCMC213U063AD2B     | 19.3                         | 8.9                           | 1 3/8 x 4 5/8               |
| 21000                        | DCMC213U063EB2B     | 19.5                         | 9.4                           | 1 3/4 x 3 1/8               |
| 25000                        | DCMC253U063AE2B     | 17.3                         | 10.6                          | 1 3/8 x 5 1/8               |
| 25000                        | DCMC253U063BB2B     | 18.1                         | 10.8                          | 2 x 3 1/8                   |
| 27000                        | DCMC273U063EJ2B     | 16.2                         | 11.9                          | 1 3/4 x 3 5/8               |
| 28000                        | DCMC283U063AF2B     | 15.8                         | 12.5                          | 1 3/8 x 5 5/8               |
| 29000                        | DCMC293U063CH2B     | 26.8                         | 9.9                           | 2 1/2 x 2 5/8               |
| 32000                        | DCMC323U063BJ2B     | 15.1                         | 10.2                          | 2 x 3 5/8                   |
| 33000                        | DCMC333U063EC2B     | 14.2                         | 11.3                          | 1 3/4 x 4 1/8               |
| 39000                        | DCMC393U063ED2B     | 12.8                         | 12.7                          | 1 3/4 x 4 5/8               |
| 39000                        | DCMC393U063BC2B     | 13.3                         | 13.1                          | 2 x 4 1/8                   |
| 41000                        | DCMC413U063CB2B     | 19.3                         | 11.4                          | 2 1/2 x 3 1/8               |
| 45000                        | DCMC453U063EE2B     | 11.8                         | 15.1                          | 1 3/4 x 5 1/8               |
| 46000                        | DCMC463U063BD2B     | 12.1                         | 15.5                          | 2 x 4 5/8                   |
| 51000                        | DCMC513U063EF2B     | 11.2                         | 16.6                          | 1 3/4 x 5 5/8               |
| 52000                        | DCMC523U063CJ2B     | 17.1                         | 11.8                          | 2 1/2 x 3 5/8               |
| 53000                        | DCMC533U063BE2B     | 11.3                         | 15.5                          | 2 x 5 1/8                   |
| 60000                        | DCMC603U063BF2B     | 10.7                         | 16.7                          | 2 x 5 5/8                   |
| 61000                        | DCMC613U063DB2B     | 14.9                         | 14.8                          | 3 x 3 1/8                   |
| 64000                        | DCMC643U063CC2B     | 13.7                         | 16.0                          | 2 1/2 x 4 1/8               |
| 76000                        | DCMC763U063CD2B     | 11.8                         | 17.8                          | 2 1/2 x 4 5/8               |
| 78000                        | DCMC783U063DJ2B     | 12.1                         | 18.1                          | 3 x 3 5/8                   |
| 87000                        | DCMC873U063CE2B     | 11.0                         | 17.6                          | 2 1/2 x 5 1/8               |
| 95000                        | DCMC953U063DC2B     | 10.8                         | 18.6                          | 3 x 4 1/8                   |
| 99000                        | DCMC993U063CF2B     | 10.5                         | 19.7                          | 2 1/2 x 5 5/8               |
| 110000                       | DCMC114U063DD2B     | 9.9                          | 21.0                          | 3 x 4 5/8                   |
| 130000                       | DCMC134U063DE2B     | 8.8                          | 23.0                          | 3 x 5 1/8                   |
| 130000                       | DCMC134U063FC2D     | 9.9                          | 22.3                          | 3 1/2 x 4 1/8               |
| 150000                       | DCMC154U063DF2B     | 7.9                          | 25.3                          | 3 x 5 5/8                   |
| 150000                       | DCMC154U063FD2D     | 9.0                          | 26.8                          | 3 1/2 x 4 5/8               |
| 160000                       | DCMC164U063DP2B     | 7.5                          | 25.5                          | 3 x 5 7/8                   |
| 180000                       | DCMC184U063FE2D     | 7.9                          | 25.7                          | 3 1/2 x 5 1/8               |
| 200000                       | DCMC204U063FF2D     | 7.2                          | 28.0                          | 3 1/2 x 5 5/8               |

| Cap. (µF)                    | Catalog Part Number | ESR Max. @ 25 °C 120 Hz (mΩ) | Ripple Max. @ 85°C 120 Hz (A) | Nominal Size D x L (inches) |
|------------------------------|---------------------|------------------------------|-------------------------------|-----------------------------|
| 210000                       | DCMC214U063FP2D     | 6.8                          | 29.4                          | 3 1/2 x 5 7/8               |
| 230000                       | DCMC234U063DN2D     | 6.5                          | 31.2                          | 3 x 7 5/8                   |
| 250000                       | DCMC254U063DG2D     | 5.7                          | 32.6                          | 3 x 8 5/8                   |
| 300000                       | DCMC304U063FN2D     | 5.8                          | 35.3                          | 3 1/2 x 7 5/8               |
| 350000                       | DCMC354U063FG2D     | 5.2                          | 38.5                          | 3 1/2 x 8 5/8               |
| <b>75 Vdc (95 Vdc Surge)</b> |                     |                              |                               |                             |
| 3200                         | DCMC322U075AK2B     | 76.2                         | 3.2                           | 1 3/8 x 1 5/8               |
| 5300                         | DCMC532U075AA2B     | 50.7                         | 4.4                           | 1 3/8 x 2 1/8               |
| 6400                         | DCMC642U075AH2B     | 41.7                         | 5.2                           | 1 3/8 x 2 5/8               |
| 9000                         | DCMC902U075AB2B     | 38.6                         | 5.8                           | 1 3/8 x 3 1/8               |
| 9900                         | DCMC992U075EA2B     | 55.6                         | 5.1                           | 1 3/4 x 2 1/8               |
| 12000                        | DCMC123U075AJ2B     | 34.3                         | 6.8                           | 1 3/8 x 3 5/8               |
| 12000                        | DCMC123U075EH2B     | 47.3                         | 6.1                           | 1 3/4 x 2 5/8               |
| 12000                        | DCMC123U075BA2B     | 34.8                         | 7.4                           | 2 x 2 1/8                   |
| 14000                        | DCMC143U075AC2B     | 30.5                         | 8.1                           | 1 3/8 x 4 1/8               |
| 14000                        | DCMC143U075BH2B     | 27.5                         | 6.9                           | 2 x 2 5/8                   |
| 16000                        | DCMC163U075EB2B     | 34.1                         | 6.7                           | 1 3/4 x 3 1/8               |
| 17000                        | DCMC173U075AD2B     | 26.2                         | 8.2                           | 1 3/8 x 4 5/8               |
| 19000                        | DCMC193U075AE2B     | 23.8                         | 9.0                           | 1 3/8 x 5 1/8               |
| 19000                        | DCMC193U075BB2B     | 21.4                         | 10.0                          | 2 x 3 1/8                   |
| 21000                        | DCMC213U075EJ2B     | 26.9                         | 9.3                           | 1 3/4 x 3 5/8               |
| 22000                        | DCMC223U075AF2B     | 21.4                         | 10.8                          | 1 3/8 x 5 5/8               |
| 23000                        | DCMC233U075CH2B     | 30.0                         | 9.4                           | 2 1/2 x 2 5/8               |
| 25000                        | DCMC253U075BJ2B     | 18.0                         | 9.3                           | 2 x 3 5/8                   |
| 26000                        | DCMC263U075EC2B     | 22.3                         | 9.0                           | 1 3/4 x 4 1/8               |
| 30000                        | DCMC303U075ED2B     | 19.2                         | 10.4                          | 1 3/4 x 4 5/8               |
| 30000                        | DCMC303U075BC2B     | 15.6                         | 12.1                          | 2 x 4 1/8                   |
| 32000                        | DCMC323U075CB2B     | 21.6                         | 10.7                          | 2 1/2 x 3 1/8               |
| 35000                        | DCMC353U075EE2B     | 16.9                         | 12.6                          | 1 3/4 x 5 1/8               |
| 35000                        | DCMC353U075BD2B     | 13.9                         | 14.4                          | 2 x 4 5/8                   |
| 40000                        | DCMC403U075EF2B     | 15.2                         | 14.3                          | 1 3/4 x 5 5/8               |
| 41000                        | DCMC413U075BE2B     | 12.8                         | 13.7                          | 2 x 5 1/8                   |
| 41000                        | DCMC413U075CJ2B     | 17.8                         | 12.3                          | 2 1/2 x 3 5/8               |
| 46000                        | DCMC463U075BF2B     | 12.0                         | 15.8                          | 2 x 5 5/8                   |
| 47000                        | DCMC473U075DB2B     | 18.0                         | 13.4                          | 3 x 3 1/8                   |
| 50000                        | DCMC503U075CC2B     | 15.1                         | 15.2                          | 2 1/2 x 4 1/8               |
| 59000                        | DCMC593U075CD2B     | 13.5                         | 16.7                          | 2 1/2 x 4 5/8               |
| 61000                        | DCMC613U075DJ2B     | 14.4                         | 16.6                          | 3 x 3 5/8                   |
| 68000                        | DCMC683U075CE2B     | 12.0                         | 16.8                          | 2 1/2 x 5 1/8               |
| 74000                        | DCMC743U075DC2B     | 12.9                         | 17.0                          | 3 x 4 1/8                   |
| 77000                        | DCMC773U075CF2B     | 11.2                         | 19.0                          | 2 1/2 x 5 5/8               |
| 88000                        | DCMC883U075DD2B     | 11.8                         | 19.2                          | 3 x 4 5/8                   |
| 100000                       | DCMC104U075DE2B     | 10.4                         | 21.1                          | 3 x 5 1/8                   |
| 100000                       | DCMC104U075FC2D     | 11.8                         | 20.4                          | 3 1/2 x 4 1/8               |
| 110000                       | DCMC114U075DF2B     | 9.4                          | 23.3                          | 3 x 5 5/8                   |
| 120000                       | DCMC124U075DP2B     | 8.9                          | 26.9                          | 3 x 5 7/8                   |
| 120000                       | DCMC124U075FD2D     | 10.7                         | 21.4                          | 3 1/2 x 4 5/8               |
| 140000                       | DCMC144U075FE2D     | 9.4                          | 23.7                          | 3 1/2 x 5 1/8               |

# Type DCMC 85 °C High Capacitance, Screw Terminal, Aluminum

## Highest Capacitance Screw Terminal Type

| Cap. (µF)                      | Catalog Part Number | ESR Max. @ 25 °C 120 Hz (mΩ) | Ripple Max. @ 85°C 120 Hz (A) | Nominal Size D x L (inches) |
|--------------------------------|---------------------|------------------------------|-------------------------------|-----------------------------|
| 160000                         | DCMC164U075FF2D     | 8.4                          | 25.7                          | 3 1/2 x 5 5/8               |
| 170000                         | DCMC174U075DN2D     | 7.7                          | 28.1                          | 3 x 7 5/8                   |
| 170000                         | DCMC174U075FP2D     | 8.1                          | 27.1                          | 3 1/2 x 5 7/8               |
| 200000                         | DCMC204U075DG2B     | 6.8                          | 29.8                          | 3 x 8 5/8                   |
| 230000                         | DCMC234U075FN2D     | 6.9                          | 32.3                          | 3 1/2 x 7 5/8               |
| 270000                         | DCMC274U075FG2D     | 6.2                          | 35.2                          | 3 1/2 x 8 5/8               |
| <b>100 Vdc (125 Vdc Surge)</b> |                     |                              |                               |                             |
| 1900                           | DCMC192U100AK2B     | 98.4                         | 2.9                           | 1 3/8 x 1 5/8               |
| 3100                           | DCMC312U100AA2B     | 60.2                         | 4.0                           | 1 3/8 x 2 1/8               |
| 3900                           | DCMC392U100AH2B     | 51.0                         | 4.7                           | 1 3/8 x 2 5/8               |
| 5500                           | DCMC552U100AB2B     | 43.4                         | 5.5                           | 1 3/8 x 3 1/8               |
| 6000                           | DCMC602U100EA2B     | 62.0                         | 4.8                           | 1 3/4 x 2 1/8               |
| 6300                           | DCMC632U100BA2B     | 51.8                         | 5.6                           | 2 x 2 1/8                   |
| 7000                           | DCMC702U100AJ2B     | 36.5                         | 6.9                           | 1 3/8 x 3 5/8               |
| 7100                           | DCMC712U100EH2B     | 52.8                         | 6.0                           | 1 3/4 x 2 5/8               |
| 8600                           | DCMC862U100AC2B     | 33.3                         | 7.8                           | 1 3/8 x 4 1/8               |
| 9000                           | DCMC902U100BH2B     | 37.8                         | 5.9                           | 2 x 2 5/8                   |
| 9900                           | DCMC992U100EB2B     | 38.0                         | 6.4                           | 1 3/4 x 3 1/8               |
| 10000                          | DCMC103U100AD2B     | 31.1                         | 7.5                           | 1 3/8 x 4 5/8               |
| 12000                          | DCMC123U100AE2B     | 30.0                         | 8.0                           | 1 3/8 x 5 1/8               |
| 13000                          | DCMC133U100AF2B     | 29.0                         | 8.6                           | 1 3/8 x 5 5/8               |
| 13000                          | DCMC133U100EJ2B     | 29.9                         | 8.8                           | 1 3/4 x 3 5/8               |
| 13000                          | DCMC133U100BB2B     | 30.6                         | 9.0                           | 2 x 3 1/8                   |
| 15000                          | DCMC153U100CH2B     | 33.7                         | 8.9                           | 2 1/2 x 2 5/8               |
| 16000                          | DCMC163U100EC2B     | 24.8                         | 8.0                           | 1 3/4 x 4 1/8               |
| 16000                          | DCMC163U100BJ2B     | 22.3                         | 9.0                           | 2 x 3 5/8                   |
| 18000                          | DCMC183U100ED2B     | 21.2                         | 9.8                           | 1 3/4 x 4 5/8               |
| 20000                          | DCMC203U100BC2B     | 19.9                         | 10.7                          | 2 x 4 1/8                   |
| 21000                          | DCMC213U100EE2B     | 18.7                         | 11.5                          | 1 3/4 x 5 1/8               |
| 21000                          | DCMC213U100CB2B     | 23.4                         | 10.7                          | 2 1/2 x 3 1/8               |
| 23000                          | DCMC233U100BD2B     | 17.7                         | 12.8                          | 2 x 4 5/8                   |
| 24000                          | DCMC243U100EF2B     | 16.8                         | 13.6                          | 1 3/4 x 5 5/8               |
| 27000                          | DCMC273U100BE2B     | 15.6                         | 12.4                          | 2 x 5 1/8                   |
| 27000                          | DCMC273U100CJ2B     | 19.1                         | 11.9                          | 2 1/2 x 3 5/8               |
| 31000                          | DCMC313U100BF2B     | 14.9                         | 14.1                          | 2 x 5 5/8                   |
| 31000                          | DCMC313U100DB2B     | 19.9                         | 12.8                          | 3 x 3 1/8                   |
| 33000                          | DCMC333U100CC2B     | 16.5                         | 14.6                          | 2 1/2 x 4 1/8               |
| 39000                          | DCMC393U100CD2B     | 14.7                         | 16.0                          | 2 1/2 x 4 5/8               |
| 40000                          | DCMC403U100DJ2B     | 16.4                         | 15.6                          | 3 x 3 5/8                   |
| 45000                          | DCMC453U100CE2B     | 13.4                         | 15.9                          | 2 1/2 x 5 1/8               |
| 49000                          | DCMC493U100DC2B     | 14.4                         | 16.1                          | 3 x 4 1/8                   |
| 51000                          | DCMC513U100CF2B     | 12.5                         | 18.0                          | 2 1/2 x 5 5/8               |
| 58000                          | DCMC583U100DD2B     | 13.0                         | 18.3                          | 3 x 4 5/8                   |
| 67000                          | DCMC673U100DE2B     | 12.0                         | 19.7                          | 3 x 5 1/8                   |
| 67000                          | DCMC673U100FC2D     | 13.4                         | 19.2                          | 3 1/2 x 4 1/8               |
| 76000                          | DCMC763U100DF2B     | 11.2                         | 21.3                          | 3 x 5 5/8                   |
| 79000                          | DCMC793U100FD2D     | 12.1                         | 23.1                          | 3 1/2 x 4 5/8               |
| 80000                          | DCMC803U100DP2B     | 11.1                         | 21.0                          | 3 x 5 7/8                   |

| Cap. (µF)                      | Catalog Part Number | ESR Max. @ 25 °C 120 Hz (mΩ) | Ripple Max. @ 85°C 120 Hz (A) | Nominal Size D x L (inches) |
|--------------------------------|---------------------|------------------------------|-------------------------------|-----------------------------|
| 92000                          | DCMC923U100FE2D     | 10.9                         | 22.0                          | 3 1/2 x 5 1/8               |
| 100000                         | DCMC104U100FF2D     | 10.2                         | 23.4                          | 3 1/2 x 5 5/8               |
| 110000                         | DCMC114U100DN2B     | 9.2                          | 25.8                          | 3 x 7 5/8                   |
| 110000                         | DCMC114U100FP2D     | 10.0                         | 24.3                          | 3 1/2 x 5 7/8               |
| 130000                         | DCMC134U100DG2B     | 8.2                          | 27.3                          | 3 x 8 5/8                   |
| 150000                         | DCMC154U100FN2D     | 8.3                          | 29.5                          | 3 1/2 x 7 5/8               |
| 180000                         | DCMC184U100FG2D     | 7.3                          | 32.3                          | 3 1/2 x 8 5/8               |
| <b>160 Vdc (200 Vdc Surge)</b> |                     |                              |                               |                             |
| 1100                           | DCMC112T160AK2B     | 149.6                        | 2.3                           | 1 3/8 x 1 5/8               |
| 1800                           | DCMC182T160AA2B     | 93.0                         | 3.3                           | 1 3/8 x 2 1/8               |
| 2300                           | DCMC232T160AH2B     | 70.5                         | 4.0                           | 1 3/8 x 2 5/8               |
| 3200                           | DCMC322T160AB2B     | 58.5                         | 4.7                           | 1 3/8 x 3 1/8               |
| 3500                           | DCMC352T160EA2B     | 62.0                         | 4.8                           | 1 3/4 x 2 1/8               |
| 3700                           | DCMC372T160BA2B     | 70.5                         | 4.8                           | 2 x 2 1/8                   |
| 4100                           | DCMC412T160AJ2B     | 50.2                         | 5.9                           | 1 3/8 x 3 5/8               |
| 4100                           | DCMC412T160EH2B     | 52.8                         | 6.0                           | 1 3/4 x 2 5/8               |
| 5000                           | DCMC502T160AC2B     | 42.9                         | 6.9                           | 1 3/8 x 4 1/8               |
| 5300                           | DCMC532T160BH2B     | 46.5                         | 5.3                           | 2 x 2 5/8                   |
| 5800                           | DCMC582T160EB2B     | 38.0                         | 6.4                           | 1 3/4 x 3 1/8               |
| 5900                           | DCMC592T160AD2B     | 37.7                         | 6.8                           | 1 3/8 x 4 5/8               |
| 6800                           | DCMC682T160AE2B     | 34.7                         | 7.5                           | 1 3/8 x 5 1/8               |
| 7400                           | DCMC742T160EJ2B     | 29.9                         | 8.4                           | 1 3/4 x 3 5/8               |
| 7400                           | DCMC742T160BB2B     | 33.5                         | 8.3                           | 2 x 3 1/8                   |
| 7700                           | DCMC772T160AF2B     | 32.2                         | 8.8                           | 1 3/8 x 5 5/8               |
| 8300                           | DCMC832T160CH2B     | 30.1                         | 9.4                           | 2 1/2 x 2 5/8               |
| 9100                           | DCMC912T160EC2B     | 24.8                         | 8.0                           | 1 3/4 x 4 1/8               |
| 9500                           | DCMC952T160BJ2B     | 26.4                         | 8.3                           | 2 x 3 5/8                   |
| 11000                          | DCMC113T160ED2B     | 21.2                         | 9.8                           | 1 3/4 x 4 5/8               |
| 12000                          | DCMC123T160EE2B     | 18.7                         | 11.0                          | 1 3/4 x 5 1/8               |
| 12000                          | DCMC123T160BC2B     | 21.9                         | 10.7                          | 2 x 4 1/8                   |
| 12000                          | DCMC123T160CB2B     | 21.3                         | 11.2                          | 2 1/2 x 3 1/8               |
| 14000                          | DCMC143T160EF2B     | 16.8                         | 13.1                          | 1 3/4 x 5 5/8               |
| 14000                          | DCMC143T160BD2B     | 18.8                         | 12.8                          | 2 x 4 5/8                   |
| 15000                          | DCMC153T160CJ2B     | 17.0                         | 11.9                          | 2 1/2 x 3 5/8               |
| 16000                          | DCMC163T160BE2B     | 16.6                         | 12.8                          | 2 x 5 1/8                   |
| 17000                          | DCMC173T160DB2B     | 14.7                         | 14.3                          | 3 x 3 1/8                   |
| 18000                          | DCMC183T160BF2B     | 14.9                         | 14.8                          | 2 x 5 5/8                   |
| 18000                          | DCMC183T160CC2B     | 14.1                         | 15.8                          | 2 1/2 x 4 1/8               |
| 22000                          | DCMC223T160CD2B     | 11.9                         | 17.8                          | 2 1/2 x 4 5/8               |
| 22000                          | DCMC223T160DJ2B     | 11.5                         | 18.6                          | 3 x 3 5/8                   |
| 25000                          | DCMC253T160CE2B     | 10.7                         | 17.8                          | 2 1/2 x 5 1/8               |
| 27000                          | DCMC273T160DC2B     | 9.6                          | 19.7                          | 3 x 4 1/8                   |
| 28000                          | DCMC283T160CF2B     | 9.6                          | 20.5                          | 2 1/2 x 5 5/8               |
| 32000                          | DCMC323T160DD2B     | 8.2                          | 23.0                          | 3 x 4 5/8                   |
| 37000                          | DCMC373T160DE2B     | 7.3                          | 25.3                          | 3 x 5 1/8                   |
| 37000                          | DCMC373T160FC2D     | 9.2                          | 23.2                          | 3 1/2 x 4 1/8               |
| 42000                          | DCMC423T160DF2B     | 6.5                          | 27.9                          | 3 x 5 5/8                   |
| 44000                          | DCMC443T160FD2D     | 7.9                          | 28.6                          | 3 1/2 x 4 5/8               |



# Type DCMC 85 °C High Capacitance, Screw Terminal, Aluminum

## Highest Capacitance Screw Terminal Type

| Cap. (µF)                      | Catalog Part Number | ESR Max. @ 25 °C 120 Hz (mΩ) | Ripple Max. @ 85°C 120 Hz (A) | Nominal Size D x L (inches) |
|--------------------------------|---------------------|------------------------------|-------------------------------|-----------------------------|
| 45000                          | DCMC453T160DP2B     | 6.2                          | 28.1                          | 3 x 5 7/8                   |
| 51000                          | DCMC513T160FE2D     | 6.9                          | 27.5                          | 3 1/2 x 5 1/8               |
| 58000                          | DCMC583T160FF2D     | 6.2                          | 30.0                          | 3 1/2 x 5 5/8               |
| 61000                          | DCMC613T160FP2D     | 5.9                          | 31.6                          | 3 1/2 x 5 7/8               |
| 62000                          | DCMC623T160DN2D     | 5.1                          | 34.9                          | 3 x 7 5/8                   |
| 72000                          | DCMC723T160DG2D     | 4.3                          | 37.5                          | 3 x 8 5/8                   |
| 85000                          | DCMC853T160FN2D     | 4.9                          | 38.8                          | 3 1/2 x 7 5/8               |
| 99000                          | DCMC993T160FG2D     | 4.2                          | 42.8                          | 3 1/2 x 8 5/8               |
| <b>200 Vdc (250 Vdc Surge)</b> |                     |                              |                               |                             |
| 680                            | DCMC681T200AK2B     | 205.8                        | 2.0                           | 1 3/8 x 1 5/8               |
| 1000                           | DCMC102T200AA2B     | 140.3                        | 2.6                           | 1 3/8 x 2 1/8               |
| 1500                           | DCMC152T200AH2B     | 100.5                        | 3.4                           | 1 3/8 x 2 5/8               |
| 1800                           | DCMC182T200AB2B     | 78.5                         | 4.1                           | 1 3/8 x 3 1/8               |
| 1900                           | DCMC192T200EA2B     | 79.1                         | 4.3                           | 1 3/4 x 2 1/8               |
| 2200                           | DCMC222T200AJ2B     | 63.9                         | 5.0                           | 1 3/8 x 3 5/8               |
| 2400                           | DCMC242T200EH2B     | 62.5                         | 5.3                           | 1 3/4 x 2 5/8               |
| 2500                           | DCMC252T200BA2B     | 82.0                         | 4.8                           | 2 x 2 1/8                   |
| 2700                           | DCMC272T200AC2B     | 51.7                         | 6.2                           | 1 3/8 x 4 1/8               |
| 3100                           | DCMC312T200EB2B     | 48.4                         | 5.2                           | 1 3/4 x 3 1/8               |
| 3300                           | DCMC332T200AD2B     | 43.2                         | 6.0                           | 1 3/8 x 4 5/8               |
| 3300                           | DCMC332T200BH2B     | 61.0                         | 5.3                           | 2 x 2 5/8                   |
| 3800                           | DCMC382T200EJ2B     | 37.9                         | 7.2                           | 1 3/4 x 3 5/8               |
| 3900                           | DCMC392T200AE2B     | 37.8                         | 7.5                           | 1 3/8 x 5 1/8               |
| 4300                           | DCMC432T200BB2B     | 46.1                         | 7.1                           | 2 x 3 1/8                   |
| 4500                           | DCMC452T200AF2B     | 33.4                         | 8.6                           | 1 3/8 x 5 5/8               |
| 4600                           | DCMC462T200EC2B     | 31.3                         | 9.2                           | 1 3/4 x 4 1/8               |
| 5400                           | DCMC542T200ED2B     | 26.8                         | 7.7                           | 1 3/4 x 4 5/8               |
| 5500                           | DCMC552T200CH2B     | 42.2                         | 6.6                           | 2 1/2 x 2 5/8               |
| 5600                           | DCMC562T200BJ2B     | 36.2                         | 7.5                           | 2 x 3 5/8                   |
| 6100                           | DCMC612T200EE2B     | 23.5                         | 9.9                           | 1 3/4 x 5 1/8               |
| 6900                           | DCMC692T200EF2B     | 21.0                         | 10.9                          | 1 3/4 x 5 5/8               |
| 6900                           | DCMC692T200BC2B     | 28.5                         | 9.7                           | 2 x 4 1/8                   |
| 7100                           | DCMC712T200CB2B     | 31.2                         | 9.6                           | 2 1/2 x 3 1/8               |
| 8200                           | DCMC822T200BD2B     | 24.4                         | 11.2                          | 2 x 4 5/8                   |
| 9100                           | DCMC912T200BE2B     | 21.7                         | 10.5                          | 2 x 5 1/8                   |
| 10000                          | DCMC103T200BF2B     | 19.6                         | 11.7                          | 2 x 5 5/8                   |
| 10000                          | DCMC103T200CJ2B     | 22.3                         | 11.6                          | 2 1/2 x 3 5/8               |
| 11000                          | DCMC113T200CC2B     | 20.3                         | 12.7                          | 2 1/2 x 4 1/8               |
| 11000                          | DCMC113T200DB2B     | 30.3                         | 10.8                          | 3 x 3 1/8                   |
| 12000                          | DCMC123T200CD2B     | 17.3                         | 14.7                          | 2 1/2 x 4 5/8               |
| 13000                          | DCMC133T200CE2B     | 15.8                         | 15.9                          | 2 1/2 x 5 1/8               |
| 13000                          | DCMC133T200DJ2B     | 23.7                         | 12.0                          | 3 x 3 5/8                   |
| 15000                          | DCMC153T200CF2B     | 13.7                         | 16.5                          | 2 1/2 x 5 5/8               |
| 15000                          | DCMC153T200DC2B     | 19.7                         | 14.3                          | 3 x 4 1/8                   |
| 18000                          | DCMC183T200DD2B     | 16.9                         | 16.1                          | 3 x 4 5/8                   |
| 21000                          | DCMC213T200FC2B     | 17.1                         | 16.5                          | 3 1/2 x 4 1/8               |
| 22000                          | DCMC223T200DE2B     | 14.8                         | 18.2                          | 3 x 5 1/8                   |
| 24000                          | DCMC243T200DF2B     | 13.3                         | 19.5                          | 3 x 5 5/8                   |

| Cap. (µF)                      | Catalog Part Number | ESR Max. @ 25 °C 120 Hz (mΩ) | Ripple Max. @ 85°C 120 Hz (A) | Nominal Size D x L (inches) |
|--------------------------------|---------------------|------------------------------|-------------------------------|-----------------------------|
| 25000                          | DCMC253T200FD2B     | 15.3                         | 20.5                          | 3 1/2 x 4 5/8               |
| 26000                          | DCMC263T200DP2B     | 12.7                         | 19.7                          | 3 x 5 7/8                   |
| 28000                          | DCMC283T200FE2B     | 13.4                         | 19.8                          | 3 1/2 x 5 1/8               |
| 31000                          | DCMC313T200FF2B     | 12.0                         | 21.6                          | 3 1/2 x 5 5/8               |
| 33000                          | DCMC333T200DN2B     | 10.8                         | 23.7                          | 3 x 7 5/8                   |
| 33000                          | DCMC333T200FP2D     | 11.5                         | 22.7                          | 3 1/2 x 5 7/8               |
| 37000                          | DCMC373T200DG2B     | 9.6                          | 25.2                          | 3 x 8 5/8                   |
| 44000                          | DCMC443T200FN2D     | 9.3                          | 28.2                          | 3 1/2 x 7 5/8               |
| 51000                          | DCMC513T200FG2D     | 7.9                          | 31.1                          | 3 1/2 x 8 5/8               |
| <b>250 Vdc (300 Vdc Surge)</b> |                     |                              |                               |                             |
| 470                            | DCMC471T250AK2B     | 259.7                        | 1.8                           | 1 3/8 x 1 5/8               |
| 820                            | DCMC821T250AA2B     | 156.4                        | 2.5                           | 1 3/8 x 2 1/8               |
| 1200                           | DCMC122T250AH2B     | 118.7                        | 3.1                           | 1 3/8 x 2 5/8               |
| 1400                           | DCMC142T250EA2B     | 99.0                         | 3.6                           | 1 3/4 x 2 1/8               |
| 1500                           | DCMC152T250AB2B     | 88.0                         | 4.1                           | 1 3/8 x 3 1/8               |
| 1800                           | DCMC182T250EH2B     | 83.3                         | 4.4                           | 1 3/4 x 2 5/8               |
| 1800                           | DCMC182T250BA2B     | 94.7                         | 4.3                           | 2 x 2 1/8                   |
| 1900                           | DCMC192T250AJ2B     | 69.5                         | 5.2                           | 1 3/8 x 3 5/8               |
| 2300                           | DCMC232T250AC2B     | 57.9                         | 5.9                           | 1 3/8 x 4 1/8               |
| 2300                           | DCMC232T250EB2B     | 61.3                         | 4.6                           | 1 3/4 x 3 1/8               |
| 2400                           | DCMC242T250AD2B     | 51.4                         | 5.5                           | 1 3/8 x 4 5/8               |
| 2500                           | DCMC252T250BH2B     | 65.7                         | 5.2                           | 2 x 2 5/8                   |
| 2700                           | DCMC272T250AE2B     | 44.0                         | 6.6                           | 1 3/8 x 5 1/8               |
| 3000                           | DCMC302T250EJ2B     | 48.7                         | 6.6                           | 1 3/4 x 3 5/8               |
| 3300                           | DCMC332T250BB2B     | 46.2                         | 7.1                           | 2 x 3 1/8                   |
| 3400                           | DCMC342T250AF2B     | 38.3                         | 8.0                           | 1 3/8 x 5 5/8               |
| 3700                           | DCMC372T250EC2B     | 40.5                         | 8.1                           | 1 3/4 x 4 1/8               |
| 3900                           | DCMC392T250ED2B     | 34.8                         | 6.7                           | 1 3/4 x 4 5/8               |
| 3900                           | DCMC392T250BJ2B     | 38.2                         | 6.9                           | 2 x 3 5/8                   |
| 4100                           | DCMC412T250CH2B     | 51.8                         | 6.3                           | 2 1/2 x 2 5/8               |
| 4500                           | DCMC452T250EE2B     | 30.6                         | 8.6                           | 1 3/4 x 5 1/8               |
| 4700                           | DCMC472T250BC2B     | 31.5                         | 8.9                           | 2 x 4 1/8                   |
| 5000                           | DCMC502T250EF2B     | 27.3                         | 9.9                           | 1 3/4 x 5 5/8               |
| 5200                           | DCMC522T250CB2B     | 32.1                         | 9.5                           | 2 1/2 x 3 1/8               |
| 5600                           | DCMC562T250BD2B     | 26.9                         | 10.7                          | 2 x 4 5/8                   |
| 6200                           | DCMC622T250BE2B     | 23.6                         | 10.1                          | 2 x 5 1/8                   |
| 6400                           | DCMC642T250CJ2B     | 25.1                         | 10.4                          | 2 1/2 x 3 5/8               |
| 6800                           | DCMC682T250BF2B     | 21.2                         | 11.9                          | 2 x 5 5/8                   |
| 7800                           | DCMC782T250DB2B     | 27.6                         | 10.9                          | 3 x 3 1/8                   |
| 8200                           | DCMC822T250CC2B     | 20.8                         | 13.0                          | 2 1/2 x 4 1/8               |
| 10000                          | DCMC103T250CD2B     | 17.8                         | 14.5                          | 2 1/2 x 4 5/8               |
| 10000                          | DCMC103T250DJ2B     | 21.6                         | 13.6                          | 3 x 3 5/8                   |
| 11000                          | DCMC113T250CE2B     | 15.5                         | 14.8                          | 2 1/2 x 5 1/8               |
| 12000                          | DCMC123T250CF2B     | 13.8                         | 16.5                          | 2 1/2 x 5 5/8               |
| 12000                          | DCMC123T250DC2B     | 17.6                         | 15.2                          | 3 x 4 1/8                   |
| 13000                          | DCMC133T250DD2B     | 16.3                         | 16.4                          | 3 x 4 5/8                   |
| 15000                          | DCMC153T250DE2B     | 14.3                         | 18.0                          | 3 x 5 1/8                   |
| 16000                          | DCMC163T250FC2D     | 19.5                         | 15.9                          | 3 1/2 x 4 1/8               |

# Type DCMC 85 °C High Capacitance, Screw Terminal, Aluminum

## Highest Capacitance Screw Terminal Type

| Cap. (µF)                      | Catalog Part Number | ESR Max. @ 25 °C 120 Hz (mΩ) | Ripple Max. @ 85°C 120 Hz (A) | Nominal Size D x L (inches) |
|--------------------------------|---------------------|------------------------------|-------------------------------|-----------------------------|
| 18000                          | DCMC183T250DF2B     | 12.0                         | 20.6                          | 3 x 5 5/8                   |
| 18000                          | DCMC183T250FD2D     | 17.1                         | 19.4                          | 3 1/2 x 4 5/8               |
| 19000                          | DCMC193T250DP2B     | 11.5                         | 20.6                          | 3 x 5 7/8                   |
| 21000                          | DCMC213T250FE2D     | 15.1                         | 18.7                          | 3 1/2 x 5 1/8               |
| 23000                          | DCMC233T250FF2D     | 13.4                         | 20.4                          | 3 1/2 x 5 5/8               |
| 24000                          | DCMC243T250FP2D     | 12.9                         | 21.4                          | 3 1/2 x 5 7/8               |
| 27000                          | DCMC273T250DN2D     | 9.5                          | 27.2                          | 3 x 7 5/8                   |
| 30000                          | DCMC303T250DG2B     | 7.0                          | 29.6                          | 3 x 8 5/8                   |
| 33000                          | DCMC333T250FN2D     | 10.6                         | 26.2                          | 3 1/2 x 7 5/8               |
| 38000                          | DCMC383T250FG2D     | 9.2                          | 28.8                          | 3 1/2 x 8 5/8               |
| <b>300 Vdc (350 Vdc Surge)</b> |                     |                              |                               |                             |
| 330                            | DCMC331T300AK2B     | 418.1                        | 1.4                           | 1 3/8 x 1 5/8               |
| 600                            | DCMC601T300AA2B     | 231.4                        | 2.1                           | 1 3/8 x 2 1/8               |
| 730                            | DCMC731T300AH2B     | 188.8                        | 2.5                           | 1 3/8 x 2 5/8               |
| 1000                           | DCMC102T300AB2B     | 137.5                        | 3.1                           | 1 3/8 x 3 1/8               |
| 1000                           | DCMC102T300EA2B     | 139.3                        | 3.2                           | 1 3/4 x 2 1/8               |
| 1200                           | DCMC122T300EH2B     | 117.2                        | 3.7                           | 1 3/4 x 2 5/8               |
| 1200                           | DCMC122T300BA2B     | 131.1                        | 3.6                           | 2 x 2 1/8                   |
| 1300                           | DCMC132T300AJ2B     | 106.8                        | 4.2                           | 1 3/8 x 3 5/8               |
| 1500                           | DCMC152T300AC2B     | 90.4                         | 4.7                           | 1 3/8 x 4 1/8               |
| 1500                           | DCMC152T300BH2B     | 102.6                        | 3.6                           | 2 x 2 5/8                   |
| 1700                           | DCMC172T300EB2B     | 84.5                         | 4.3                           | 1 3/4 x 3 1/8               |
| 1800                           | DCMC182T300AD2B     | 77.4                         | 4.7                           | 1 3/8 x 4 5/8               |
| 2100                           | DCMC212T300AE2B     | 65.7                         | 5.4                           | 1 3/8 x 5 1/8               |
| 2100                           | DCMC212T300EJ2B     | 68.3                         | 5.6                           | 1 3/4 x 3 5/8               |
| 2200                           | DCMC222T300BB2B     | 71.1                         | 5.7                           | 2 x 3 1/8                   |
| 2300                           | DCMC232T300AF2B     | 60.3                         | 6.4                           | 1 3/8 x 5 5/8               |
| 2600                           | DCMC262T300EC2B     | 56.7                         | 6.8                           | 1 3/4 x 4 1/8               |
| 2600                           | DCMC262T300CH2B     | 60.5                         | 5.1                           | 2 1/2 x 2 5/8               |
| 2800                           | DCMC282T300BJ2B     | 55.5                         | 5.7                           | 2 x 3 5/8                   |
| 3000                           | DCMC302T300ED2B     | 48.5                         | 6.5                           | 1 3/4 x 4 5/8               |
| 3300                           | DCMC332T300CB2B     | 46.5                         | 7.0                           | 2 1/2 x 3 1/8               |
| 3400                           | DCMC342T300BC2B     | 45.7                         | 7.4                           | 2 x 4 1/8                   |
| 3500                           | DCMC352T300EE2B     | 42.5                         | 8.0                           | 1 3/4 x 5 1/8               |
| 3900                           | DCMC392T300EF2B     | 37.9                         | 8.7                           | 1 3/4 x 5 5/8               |
| 4000                           | DCMC402T300BD2B     | 38.9                         | 8.9                           | 2 x 4 5/8                   |
| 4200                           | DCMC422T300CJ2B     | 38.1                         | 7.9                           | 2 1/2 x 3 5/8               |
| 4600                           | DCMC462T300BE2B     | 34.0                         | 8.9                           | 2 x 5 1/8                   |
| 4800                           | DCMC482T300DB2B     | 42.8                         | 8.4                           | 3 x 3 1/8                   |
| 5200                           | DCMC522T300CC2B     | 29.9                         | 10.4                          | 2 1/2 x 4 1/8               |
| 5300                           | DCMC532T300BF2B     | 30.2                         | 10.8                          | 2 x 5 5/8                   |
| 6000                           | DCMC602T300DJ2B     | 34.0                         | 10.5                          | 3 x 3 5/8                   |
| 6100                           | DCMC612T300CD2B     | 25.5                         | 12.5                          | 2 1/2 x 4 5/8               |
| 7100                           | DCMC712T300CE2B     | 22.2                         | 12.3                          | 2 1/2 x 5 1/8               |
| 7400                           | DCMC742T300DC2B     | 26.2                         | 11.9                          | 3 x 4 1/8                   |
| 8000                           | DCMC802T300CF2B     | 19.8                         | 14.3                          | 2 1/2 x 5 5/8               |
| 8700                           | DCMC872T300DD2B     | 23.6                         | 13.6                          | 3 x 4 5/8                   |
| 10000                          | DCMC103T300DE2B     | 20.5                         | 15.1                          | 3 x 5 1/8                   |

| Cap. (µF)                      | Catalog Part Number | ESR Max. @ 25 °C 120 Hz (mΩ) | Ripple Max. @ 85°C 120 Hz (A) | Nominal Size D x L (inches) |
|--------------------------------|---------------------|------------------------------|-------------------------------|-----------------------------|
| 10000                          | DCMC103T300FC2D     | 21.0                         | 15.3                          | 3 1/2 x 4 1/8               |
| 11000                          | DCMC113T300DF2B     | 18.0                         | 16.8                          | 3 x 5 5/8                   |
| 12000                          | DCMC123T300DP2B     | 17.0                         | 19.5                          | 3 x 5 7/8                   |
| 12000                          | DCMC123T300FD2D     | 18.2                         | 16.4                          | 3 1/2 x 4 5/8               |
| 13000                          | DCMC133T300FE2D     | 16.0                         | 18.1                          | 3 1/2 x 5 1/8               |
| 15000                          | DCMC153T300FF2D     | 14.3                         | 19.8                          | 3 1/2 x 5 5/8               |
| 16000                          | DCMC163T300DN2B     | 13.2                         | 21.8                          | 3 x 7 5/8                   |
| 16000                          | DCMC163T300FP2D     | 13.5                         | 20.9                          | 3 1/2 x 5 7/8               |
| 19000                          | DCMC193T300DG2B     | 10.8                         | 23.7                          | 3 x 8 5/8                   |
| 22000                          | DCMC223T300FN2D     | 11.0                         | 25.9                          | 3 1/2 x 7 5/8               |
| 26000                          | DCMC263T300FG2D     | 9.3                          | 28.6                          | 3 1/2 x 8 5/8               |
| <b>350 Vdc (400 Vdc Surge)</b> |                     |                              |                               |                             |
| 220                            | DCMC221T350AK2B     | 605.4                        | 1.2                           | 1 3/8 x 1 5/8               |
| 430                            | DCMC431T350AA2B     | 378.8                        | 1.6                           | 1 3/8 x 2 1/8               |
| 510                            | DCMC511T350AH2B     | 253.0                        | 2.1                           | 1 3/8 x 2 5/8               |
| 680                            | DCMC681T350AB2B     | 190.2                        | 2.6                           | 1 3/8 x 3 1/8               |
| 760                            | DCMC761T350EA2B     | 176.6                        | 2.9                           | 1 3/4 x 2 1/8               |
| 860                            | DCMC861T350AJ2B     | 152.5                        | 3.2                           | 1 3/8 x 3 5/8               |
| 920                            | DCMC921T350EH2B     | 161.7                        | 3.3                           | 1 3/4 x 2 5/8               |
| 990                            | DCMC991T350BA2B     | 167.6                        | 3.3                           | 2 x 2 1/8                   |
| 1000                           | DCMC102T350AC2B     | 127.5                        | 4.0                           | 1 3/8 x 4 1/8               |
| 1200                           | DCMC122T350AD2B     | 109.6                        | 3.5                           | 1 3/8 x 4 5/8               |
| 1200                           | DCMC122T350EB2B     | 124.7                        | 3.5                           | 1 3/4 x 3 1/8               |
| 1200                           | DCMC122T350BH2B     | 132.2                        | 3.6                           | 2 x 2 5/8                   |
| 1300                           | DCMC132T350AE2B     | 97.2                         | 4.5                           | 1 3/8 x 5 1/8               |
| 1500                           | DCMC152T350AF2B     | 85.9                         | 5.0                           | 1 3/8 x 5 5/8               |
| 1500                           | DCMC152T350EJ2B     | 97.3                         | 4.9                           | 1 3/4 x 3 5/8               |
| 1500                           | DCMC152T350BB2B     | 101.5                        | 4.9                           | 2 x 3 1/8                   |
| 1800                           | DCMC182T350EC2B     | 79.9                         | 5.8                           | 1 3/4 x 4 1/8               |
| 1900                           | DCMC192T350BJ2B     | 79.2                         | 4.4                           | 2 x 3 5/8                   |
| 2000                           | DCMC202T350CH2B     | 86.9                         | 4.6                           | 2 1/2 x 2 5/8               |
| 2100                           | DCMC212T350ED2B     | 67.8                         | 5.5                           | 1 3/4 x 4 5/8               |
| 2300                           | DCMC232T350BC2B     | 65.1                         | 5.9                           | 2 x 4 1/8                   |
| 2400                           | DCMC242T350EE2B     | 59.1                         | 6.5                           | 1 3/4 x 5 1/8               |
| 2500                           | DCMC252T350CB2B     | 61.0                         | 6.6                           | 2 1/2 x 3 1/8               |
| 2700                           | DCMC272T350EF2B     | 52.4                         | 7.4                           | 1 3/4 x 5 5/8               |
| 2700                           | DCMC272T350BD2B     | 55.4                         | 7.5                           | 2 x 4 5/8                   |
| 3100                           | DCMC312T350BE2B     | 48.7                         | 7.0                           | 2 x 5 1/8                   |
| 3100                           | DCMC312T350CJ2B     | 48.5                         | 7.5                           | 2 1/2 x 3 5/8               |
| 3500                           | DCMC352T350BF2B     | 42.8                         | 8.3                           | 2 x 5 5/8                   |
| 3700                           | DCMC372T350CC2B     | 39.9                         | 9.0                           | 2 1/2 x 4 1/8               |
| 3800                           | DCMC382T350DB2B     | 54.0                         | 8.1                           | 3 x 3 1/8                   |
| 4200                           | DCMC422T350CD2B     | 34.0                         | 10.5                          | 2 1/2 x 4 5/8               |
| 4600                           | DCMC462T350DJ2B     | 41.7                         | 9.8                           | 3 x 3 5/8                   |
| 4800                           | DCMC482T350CE2B     | 29.6                         | 10.7                          | 2 1/2 x 5 1/8               |
| 5400                           | DCMC542T350CF2B     | 26.2                         | 11.9                          | 2 1/2 x 5 5/8               |
| 5500                           | DCMC552T350DC2B     | 34.7                         | 10.8                          | 3 x 4 1/8                   |
| 6300                           | DCMC632T350DD2B     | 29.6                         | 12.2                          | 3 x 4 5/8                   |

# Type DCMC 85 °C High Capacitance, Screw Terminal, Aluminum

## Highest Capacitance Screw Terminal Type

| Cap. (µF)                      | Catalog Part Number | ESR Max. @ 25 °C 120 Hz (mΩ) | Ripple Max. @ 85°C 120 Hz (A) | Nominal Size D x L (inches) | Cap. (µF)                      | Catalog Part Number | ESR Max. @ 25 °C 120 Hz (mΩ) | Ripple Max. @ 85°C 120 Hz (A) | Nominal Size D x L (inches) |
|--------------------------------|---------------------|------------------------------|-------------------------------|-----------------------------|--------------------------------|---------------------|------------------------------|-------------------------------|-----------------------------|
| 7200                           | DCMC722T350DE2B     | 25.8                         | 13.4                          | 3 x 5 1/8                   | 5300                           | DCMC532T400DD2B     | 31.5                         | 11.8                          | 3 x 4 5/8                   |
| 7700                           | DCMC772T350FC2D     | 29.9                         | 12.8                          | 3 1/2 x 4 1/8               | 6000                           | DCMC602T400DE2B     | 27.4                         | 13.0                          | 3 x 5 1/8                   |
| 8200                           | DCMC822T350DF2B     | 22.9                         | 14.9                          | 3 x 5 5/8                   | 6400                           | DCMC642T400FC2D     | 31.9                         | 12.4                          | 3 1/2 x 4 1/8               |
| 8400                           | DCMC842T350DP2B     | 21.7                         | 17.2                          | 3 x 5 7/8                   | 6800                           | DCMC682T400DF2B     | 24.4                         | 14.4                          | 3 x 5 5/8                   |
| 8800                           | DCMC882T350FD2D     | 25.7                         | 13.8                          | 3 1/2 x 4 5/8               | 7100                           | DCMC712T400DP2B     | 23.1                         | 16.7                          | 3 x 5 7/8                   |
| 10000                          | DCMC103T350FE2D     | 22.5                         | 15.3                          | 3 1/2 x 5 1/8               | 7400                           | DCMC742T400FD2D     | 27.4                         | 13.4                          | 3 1/2 x 4 5/8               |
| 11000                          | DCMC113T350DN2B     | 17.1                         | 19.1                          | 3 x 7 5/8                   | 8400                           | DCMC842T400FE2D     | 23.9                         | 14.8                          | 3 1/2 x 5 1/8               |
| 11000                          | DCMC113T350FF2D     | 20.0                         | 16.7                          | 3 1/2 x 5 5/8               | 9400                           | DCMC942T400FF2D     | 21.2                         | 16.2                          | 3 1/2 x 5 5/8               |
| 12000                          | DCMC123T350FP2D     | 18.9                         | 17.7                          | 3 1/2 x 5 7/8               | 9600                           | DCMC962T400DN2B     | 18.2                         | 18.6                          | 3 x 7 5/8                   |
| 13000                          | DCMC133T350DG2B     | 14.2                         | 20.7                          | 3 x 8 5/8                   | 9900                           | DCMC992T400FP2D     | 20.1                         | 17.2                          | 3 1/2 x 5 7/8               |
| 16000                          | DCMC163T350FN2D     | 14.9                         | 22.3                          | 3 1/2 x 7 5/8               | 11000                          | DCMC113T400DG2B     | 15.1                         | 20.1                          | 3 x 8 5/8                   |
| 18000                          | DCMC183T350FG2D     | 12.4                         | 24.8                          | 3 1/2 x 8 5/8               | 13000                          | DCMC133T400FN2D     | 15.8                         | 21.7                          | 3 1/2 x 7 5/8               |
| <b>400 Vdc (450 Vdc Surge)</b> |                     |                              |                               |                             | <b>450 Vdc (500 Vdc Surge)</b> |                     |                              |                               |                             |
| 180                            | DCMC181T400AK2B     | 652.4                        | 1.1                           | 1 3/8 x 1 5/8               | 150                            | DCMC151T450AK2B     | 796.7                        | 1.0                           | 1 3/8 x 1 5/8               |
| 350                            | DCMC351T400AA2B     | 408.2                        | 1.6                           | 1 3/8 x 2 1/8               | 270                            | DCMC271T450AA2B     | 437.7                        | 1.5                           | 1 3/8 x 2 1/8               |
| 420                            | DCMC421T400AH2B     | 272.6                        | 2.1                           | 1 3/8 x 2 5/8               | 350                            | DCMC351T450AH2B     | 337.1                        | 1.8                           | 1 3/8 x 2 5/8               |
| 570                            | DCMC571T400AB2B     | 204.8                        | 2.5                           | 1 3/8 x 3 1/8               | 460                            | DCMC461T450EA2B     | 264.2                        | 2.2                           | 1 3/4 x 2 1/8               |
| 630                            | DCMC631T400EA2B     | 189.5                        | 2.8                           | 1 3/4 x 2 1/8               | 470                            | DCMC471T450AB2B     | 253.2                        | 2.4                           | 1 3/8 x 3 1/8               |
| 710                            | DCMC711T400AJ2B     | 164.3                        | 3.1                           | 1 3/8 x 3 5/8               | 560                            | DCMC561T450AJ2B     | 203.0                        | 2.8                           | 1 3/8 x 3 5/8               |
| 760                            | DCMC761T400EH2B     | 173.7                        | 3.2                           | 1 3/4 x 2 5/8               | 570                            | DCMC571T450EH2B     | 213.1                        | 2.9                           | 1 3/4 x 2 5/8               |
| 820                            | DCMC821T400BA2B     | 179.3                        | 3.2                           | 2 x 2 1/8                   | 590                            | DCMC591T450BA2B     | 228.4                        | 2.9                           | 2 x 2 1/8                   |
| 850                            | DCMC851T400AC2B     | 137.3                        | 3.8                           | 1 3/8 x 4 1/8               | 680                            | DCMC681T450AC2B     | 169.5                        | 3.4                           | 1 3/8 x 4 1/8               |
| 1000                           | DCMC102T400AD2B     | 118.0                        | 3.4                           | 1 3/8 x 4 5/8               | 740                            | DCMC741T450EB2B     | 164.5                        | 2.8                           | 1 3/4 x 3 1/8               |
| 1000                           | DCMC102T400EB2B     | 134.0                        | 3.4                           | 1 3/4 x 3 1/8               | 780                            | DCMC781T450BH2B     | 178.0                        | 2.9                           | 2 x 2 5/8                   |
| 1000                           | DCMC102T400BH2B     | 141.7                        | 3.5                           | 2 x 2 5/8                   | 820                            | DCMC821T450AD2B     | 145.6                        | 3.5                           | 1 3/8 x 4 5/8               |
| 1100                           | DCMC112T400AE2B     | 104.6                        | 4.3                           | 1 3/8 x 5 1/8               | 920                            | DCMC921T450EJ2B     | 130.9                        | 3.8                           | 1 3/4 x 3 5/8               |
| 1200                           | DCMC122T400AF2B     | 92.4                         | 4.8                           | 1 3/8 x 5 5/8               | 930                            | DCMC931T450AE2B     | 127.7                        | 4.1                           | 1 3/8 x 5 1/8               |
| 1200                           | DCMC122T400EJ2B     | 106.6                        | 4.6                           | 1 3/4 x 3 5/8               | 1000                           | DCMC102T450AF2B     | 113.9                        | 4.5                           | 1 3/8 x 5 5/8               |
| 1300                           | DCMC132T400BB2B     | 108.9                        | 4.8                           | 2 x 3 1/8                   | 1000                           | DCMC102T450BB2B     | 137.0                        | 4.3                           | 2 x 3 1/8                   |
| 1500                           | DCMC152T400EC2B     | 85.8                         | 5.6                           | 1 3/4 x 4 1/8               | 1100                           | DCMC112T450EC2B     | 107.4                        | 5.0                           | 1 3/4 x 4 1/8               |
| 1600                           | DCMC162T400BJ2B     | 85.0                         | 4.3                           | 2 x 3 5/8                   | 1200                           | DCMC122T450BJ2B     | 109.0                        | 3.8                           | 2 x 3 5/8                   |
| 1700                           | DCMC172T400ED2B     | 74.3                         | 4.9                           | 1 3/4 x 4 5/8               | 1200                           | DCMC122T450CH2B     | 115.8                        | 4.0                           | 2 1/2 x 2 5/8               |
| 1700                           | DCMC172T400CH2B     | 93.1                         | 4.7                           | 2 1/2 x 2 5/8               | 1300                           | DCMC132T450ED2B     | 91.1                         | 4.7                           | 1 3/4 x 4 5/8               |
| 1900                           | DCMC192T400BC2B     | 69.8                         | 5.7                           | 2 x 4 1/8                   | 1500                           | DCMC152T450EE2B     | 79.2                         | 5.4                           | 1 3/4 x 5 1/8               |
| 2000                           | DCMC202T400EE2B     | 63.4                         | 6.3                           | 1 3/4 x 5 1/8               | 1500                           | DCMC152T450BC2B     | 89.5                         | 5.3                           | 2 x 4 1/8                   |
| 2100                           | DCMC212T400CB2B     | 65.3                         | 6.4                           | 2 1/2 x 3 1/8               | 1700                           | DCMC172T450EF2B     | 70.2                         | 6.2                           | 1 3/4 x 5 5/8               |
| 2200                           | DCMC222T400EF2B     | 57.3                         | 7.1                           | 1 3/4 x 5 5/8               | 1700                           | DCMC172T450CB2B     | 81.1                         | 6.0                           | 2 1/2 x 3 1/8               |
| 2300                           | DCMC232T400BD2B     | 59.3                         | 7.2                           | 2 x 4 5/8                   | 1800                           | DCMC182T450BD2B     | 76.0                         | 6.4                           | 2 x 4 5/8                   |
| 2600                           | DCMC262T400BE2B     | 52.2                         | 6.8                           | 2 x 5 1/8                   | 1900                           | DCMC192T450BE2B     | 66.8                         | 6.0                           | 2 x 5 1/8                   |
| 2600                           | DCMC262T400CJ2B     | 52.0                         | 7.2                           | 2 1/2 x 3 5/8               | 2000                           | DCMC202T450CJ2B     | 66.5                         | 6.4                           | 2 1/2 x 3 5/8               |
| 2900                           | DCMC292T400BF2B     | 45.9                         | 8.1                           | 2 x 5 5/8                   | 2200                           | DCMC222T450BF2B     | 58.6                         | 7.1                           | 2 x 5 5/8                   |
| 3100                           | DCMC312T400CC2B     | 42.8                         | 8.7                           | 2 1/2 x 4 1/8               | 2400                           | DCMC242T450CC2B     | 54.7                         | 7.7                           | 2 1/2 x 4 1/8               |
| 3200                           | DCMC322T400DB2B     | 57.5                         | 7.8                           | 3 x 3 1/8                   | 2500                           | DCMC252T450DB2B     | 65.7                         | 7.3                           | 3 x 3 1/8                   |
| 3900                           | DCMC392T400CD2B     | 35.6                         | 10.3                          | 2 1/2 x 4 5/8               | 2800                           | DCMC282T450CD2B     | 46.4                         | 9.0                           | 2 1/2 x 4 5/8               |
| 3900                           | DCMC392T400DJ2B     | 44.9                         | 9.4                           | 3 x 3 5/8                   | 3000                           | DCMC302T450DJ2B     | 52.2                         | 8.7                           | 3 x 3 5/8                   |
| 4000                           | DCMC402T400CE2B     | 31.7                         | 10.3                          | 2 1/2 x 5 1/8               | 3300                           | DCMC332T450CE2B     | 40.4                         | 9.2                           | 2 1/2 x 5 1/8               |
| 4700                           | DCMC472T400CF2B     | 28.1                         | 11.5                          | 2 1/2 x 5 5/8               | 3900                           | DCMC392T450CF2B     | 35.4                         | 10.3                          | 2 1/2 x 5 5/8               |
| 4700                           | DCMC472T400DC2B     | 37.0                         | 10.5                          | 3 x 4 1/8                   |                                |                     |                              |                               |                             |

# Type DCMC 85 °C High Capacitance, Screw Terminal, Aluminum

## Highest Capacitance Screw Terminal Type

| Cap. (µF)                      | Catalog Part Number | ESR Max. @ 25 °C 120 Hz (mΩ) | Ripple Max. @ 85°C 120 Hz (A) | Nominal Size D x L (inches) |
|--------------------------------|---------------------|------------------------------|-------------------------------|-----------------------------|
| 3900                           | DCMC392T450DC2B     | 40.1                         | 10.1                          | 3 x 4 1/8                   |
| 4100                           | DCMC412T450DD2B     | 37.5                         | 10.8                          | 3 x 4 5/8                   |
| 4700                           | DCMC472T450DE2B     | 32.5                         | 12.0                          | 3 x 5 1/8                   |
| 5000                           | DCMC502T450FC2D     | 31.8                         | 12.5                          | 3 1/2 x 4 1/8               |
| 5600                           | DCMC562T450DF2B     | 28.8                         | 13.3                          | 3 x 5 5/8                   |
| 5800                           | DCMC582T450DP2B     | 27.3                         | 15.4                          | 3 x 5 7/8                   |
| 5800                           | DCMC582T450FD2D     | 27.0                         | 13.5                          | 3 1/2 x 4 5/8               |
| 6800                           | DCMC682T450FE2D     | 23.5                         | 15.0                          | 3 1/2 x 5 1/8               |
| 7300                           | DCMC732T450FF2D     | 21.1                         | 16.3                          | 3 1/2 x 5 5/8               |
| 7700                           | DCMC772T450FP2D     | 20.0                         | 17.2                          | 3 1/2 x 5 7/8               |
| 7900                           | DCMC792T450DN2B     | 21.3                         | 17.1                          | 3 x 7 5/8                   |
| 9000                           | DCMC902T450DG2B     | 17.6                         | 18.6                          | 3 x 8 5/8                   |
| 10000                          | DCMC103T450FN2D     | 15.9                         | 21.6                          | 3 1/2 x 7 5/8               |
| 12000                          | DCMC123T450FG2D     | 13.3                         | 24.0                          | 3 1/2 x 8 5/8               |
| <b>500 Vdc (550 Vdc Surge)</b> |                     |                              |                               |                             |
| 110                            | DCMC111T500AK2B     | 1224.3                       | 0.8                           | 1 3/8 x 1 5/8               |
| 180                            | DCMC181T500AA2B     | 736.9                        | 1.2                           | 1 3/8 x 2 1/8               |
| 240                            | DCMC241T500AH2B     | 556.5                        | 1.4                           | 1 3/8 x 2 5/8               |
| 270                            | DCMC271T500EA2B     | 498.4                        | 1.6                           | 1 3/4 x 2 1/8               |
| 320                            | DCMC321T500AB2B     | 409.7                        | 1.9                           | 1 3/8 x 3 1/8               |
| 340                            | DCMC341T500BA2B     | 393.1                        | 2.0                           | 2 x 2 1/8                   |
| 380                            | DCMC381T500EH2B     | 347.2                        | 2.2                           | 1 3/4 x 2 5/8               |
| 400                            | DCMC401T500AJ2B     | 338.1                        | 2.4                           | 1 3/8 x 3 5/8               |
| 470                            | DCMC471T500BH2B     | 273.9                        | 2.7                           | 2 x 2 5/8                   |
| 480                            | DCMC481T500AC2B     | 293.2                        | 2.1                           | 1 3/8 x 4 1/8               |
| 500                            | DCMC501T500EB2B     | 264.5                        | 2.4                           | 1 3/4 x 3 1/8               |
| 560                            | DCMC561T500AD2B     | 261.2                        | 2.6                           | 1 3/8 x 4 5/8               |
| 640                            | DCMC641T500AE2B     | 231.1                        | 2.9                           | 1 3/8 x 5 1/8               |
| 650                            | DCMC651T500EJ2B     | 202.0                        | 3.2                           | 1 3/4 x 3 5/8               |
| 700                            | DCMC701T500BB2B     | 200.1                        | 3.4                           | 2 x 3 1/8                   |
| 720                            | DCMC721T500AF2B     | 195.4                        | 3.6                           | 1 3/8 x 5 5/8               |
| 790                            | DCMC791T500EC2B     | 172.4                        | 3.9                           | 1 3/4 x 4 1/8               |
| 800                            | DCMC801T500CH2B     | 170.6                        | 3.0                           | 2 1/2 x 2 5/8               |
| 860                            | DCMC861T500BJ2B     | 159.1                        | 3.4                           | 2 x 3 5/8                   |
| 930                            | DCMC931T500ED2B     | 149.1                        | 3.7                           | 1 3/4 x 4 5/8               |
| 1000                           | DCMC102T500BC2B     | 138.7                        | 4.1                           | 2 x 4 1/8                   |
| 1100                           | DCMC112T500EE2B     | 129.6                        | 4.4                           | 1 3/4 x 5 1/8               |

| Cap. (µF)                      | Catalog Part Number | ESR Max. @ 25 °C 120 Hz (mΩ) | Ripple Max. @ 85°C 120 Hz (A) | Nominal Size D x L (inches) |
|--------------------------------|---------------------|------------------------------|-------------------------------|-----------------------------|
| 1100                           | DCMC112T500CB2B     | 122.0                        | 4.7                           | 2 1/2 x 3 1/8               |
| 1200                           | DCMC122T500EF2B     | 114.7                        | 5.0                           | 1 3/4 x 5 5/8               |
| 1200                           | DCMC122T500BD2B     | 117.7                        | 5.1                           | 2 x 4 5/8                   |
| 1400                           | DCMC142T500BE2B     | 102.3                        | 4.8                           | 2 x 5 1/8                   |
| 1400                           | DCMC142T500CJ2B     | 95.1                         | 5.3                           | 2 1/2 x 3 5/8               |
| 1500                           | DCMC152T500BF2B     | 93.3                         | 5.7                           | 2 x 5 5/8                   |
| 1700                           | DCMC172T500CC2B     | 79.7                         | 6.4                           | 2 1/2 x 4 1/8               |
| 1700                           | DCMC172T500DB2B     | 86.4                         | 6.4                           | 3 x 3 1/8                   |
| 2100                           | DCMC212T500CE2B     | 61.1                         | 7.8                           | 2 1/2 x 5 1/8               |
| 2200                           | DCMC222T500CD2B     | 68.3                         | 7.6                           | 2 1/2 x 4 5/8               |
| 2200                           | DCMC222T500DJ2B     | 67.4                         | 7.1                           | 3 x 3 5/8                   |
| 2500                           | DCMC252T500CF2B     | 54.7                         | 8.3                           | 2 1/2 x 5 5/8               |
| 2500                           | DCMC252T500DC2B     | 55.4                         | 8.6                           | 3 x 4 1/8                   |
| 3000                           | DCMC302T500DD2B     | 48.1                         | 9.5                           | 3 x 4 5/8                   |
| 3400                           | DCMC342T500DE2B     | 43.1                         | 10.4                          | 3 x 5 1/8                   |
| 3500                           | DCMC352T500FC2D     | 40.1                         | 11.1                          | 3 1/2 x 4 1/8               |
| 3900                           | DCMC392T500DF2B     | 37.5                         | 11.6                          | 3 x 5 5/8                   |
| 4100                           | DCMC412T500DP2B     | 35.5                         | 13.5                          | 3 x 5 7/8                   |
| 4100                           | DCMC412T500FD2D     | 34.1                         | 12.0                          | 3 1/2 x 4 5/8               |
| 4800                           | DCMC482T500FE2D     | 30.0                         | 13.2                          | 3 1/2 x 5 1/8               |
| 5400                           | DCMC542T500FF2D     | 28.0                         | 14.2                          | 3 1/2 x 5 5/8               |
| 5700                           | DCMC572T500FP2D     | 26.0                         | 15.1                          | 3 1/2 x 5 7/8               |
| 5700                           | DCMC572T500DN2B     | 27.9                         | 15.0                          | 3 x 7 5/8                   |
| 6600                           | DCMC662T500DG2B     | 23.1                         | 16.2                          | 3 x 8 5/8                   |
| 7900                           | DCMC792T500FN2D     | 20.5                         | 19.1                          | 3 1/2 x 7 5/8               |
| 9200                           | DCMC922T500FG2D     | 16.7                         | 21.4                          | 3 1/2 x 8 5/8               |
| <b>550 Vdc (600 Vdc Surge)</b> |                     |                              |                               |                             |
| 1400                           | DCMC142T550CC2B     | 170.5                        | 4.9                           | 2 1/2 x 4 1/8               |
| 1700                           | DCMC172T550CD2B     | 132.6                        | 5.9                           | 2 1/2 x 4 5/8               |
| 1900                           | DCMC192T550CE2B     | 111.7                        | 6.8                           | 2 1/2 x 5 1/8               |
| 2200                           | DCMC222T550DC2B     | 90.4                         | 7.8                           | 3 x 4 1/8                   |
| 2300                           | DCMC232T550CF2B     | 86.5                         | 7.8                           | 2 1/2 x 5 5/8               |
| 2500                           | DCMC252T550DD2B     | 79.6                         | 8.4                           | 3 x 4 5/8                   |
| 2900                           | DCMC292T550DE2B     | 64.0                         | 9.7                           | 3 x 5 1/8                   |
| 3400                           | DCMC342T550DF2B     | 54.6                         | 10.9                          | 3 x 5 5/8                   |
| 3700                           | DCMC372T550DP2B     | 50.2                         | 12.2                          | 3 x 5 7/8                   |
| 5100                           | DCMC512T550DN2B     | 36.4                         | 16.2                          | 3 x 7 5/8                   |

# Type DCMC 85 °C High Capacitance, Screw Terminal, Aluminum

## Highest Capacitance Screw Terminal Type

### Typical Performance Curves

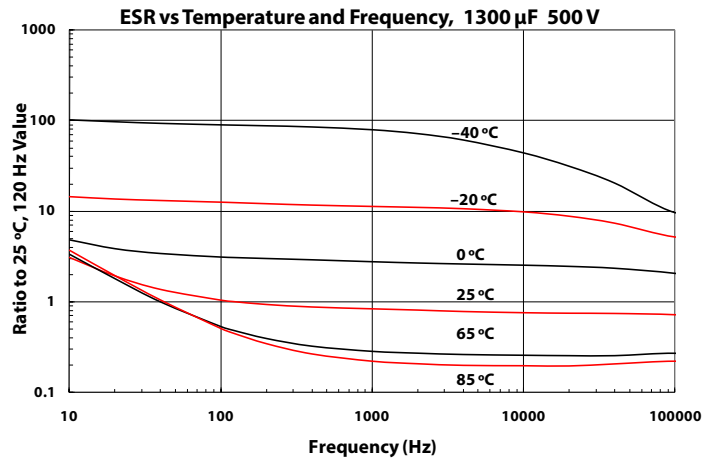
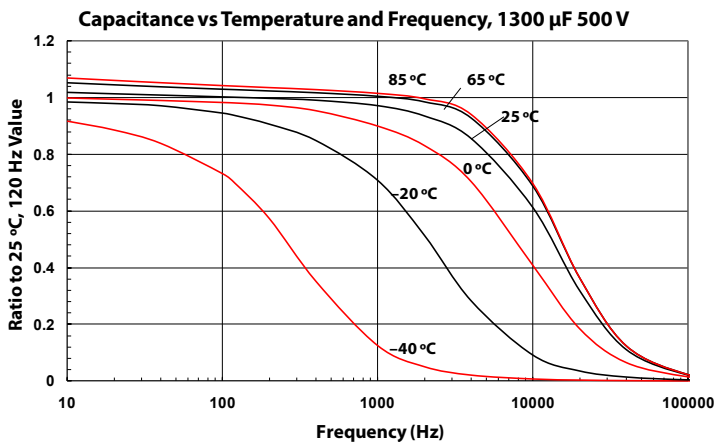
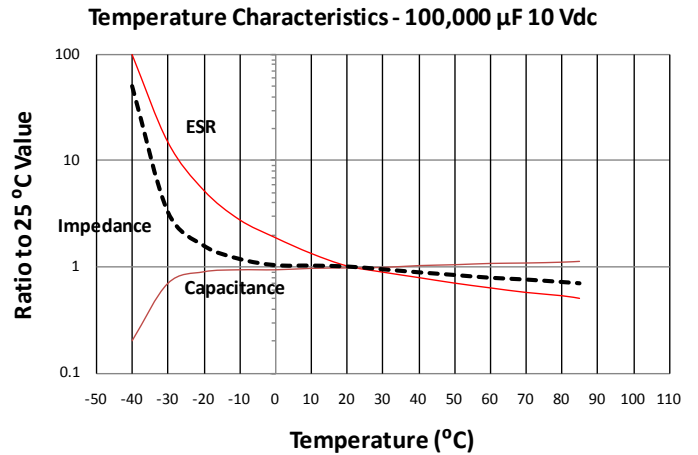
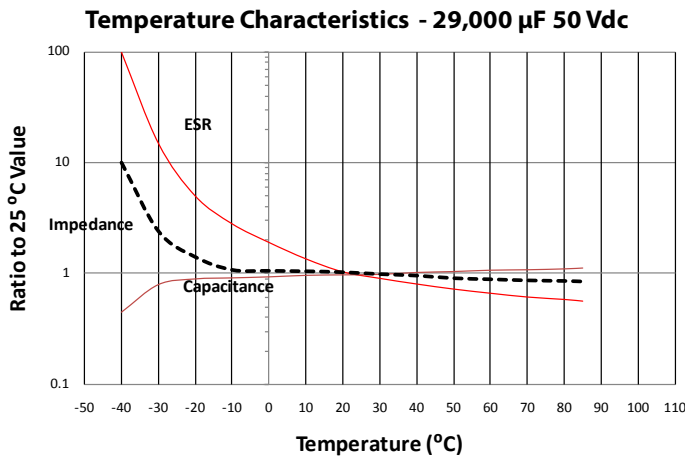
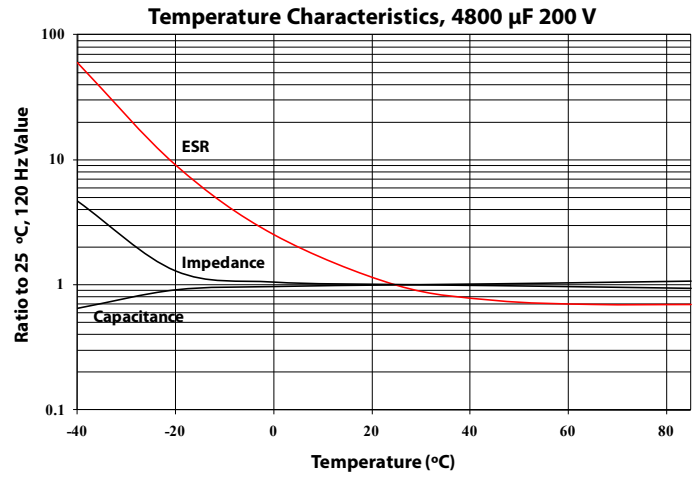
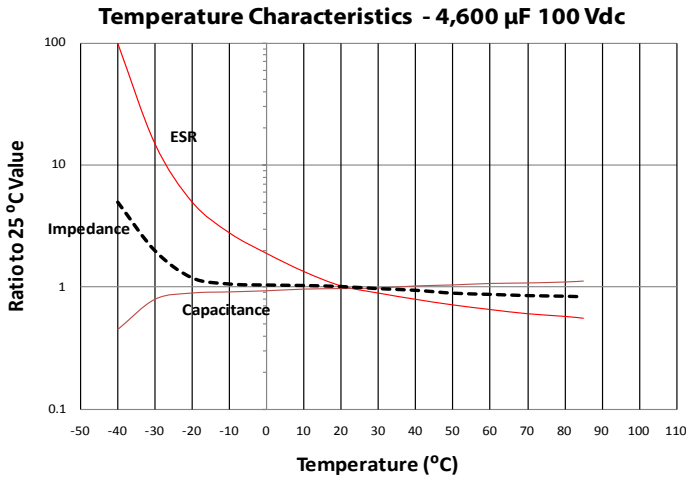

# Type DCMC 85 °C High Capacitance, Screw Terminal, Aluminum

## Highest Capacitance Screw Terminal Type

### Typical Performance Curves

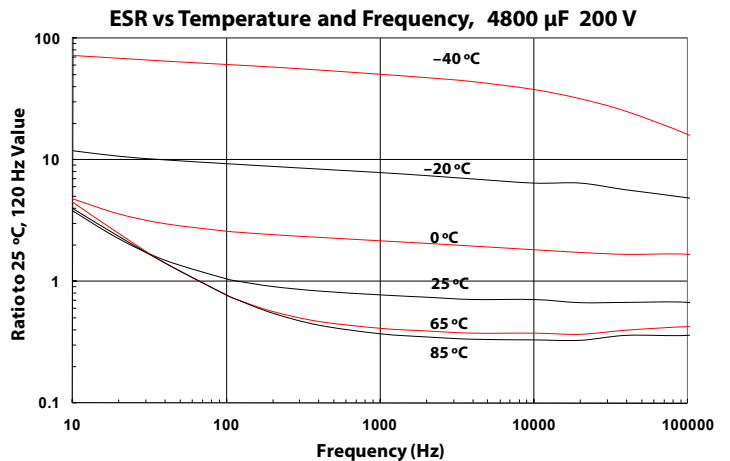
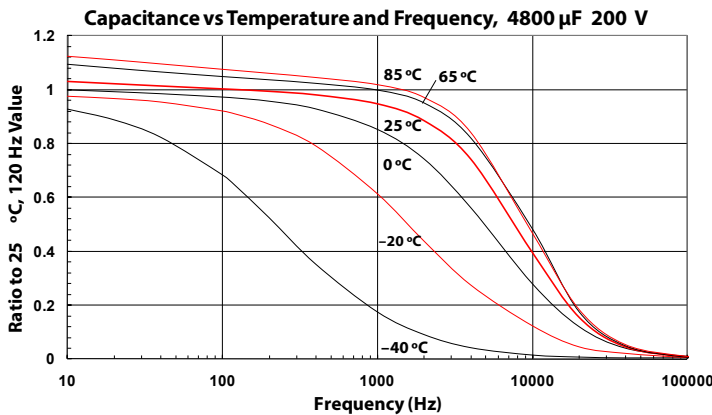
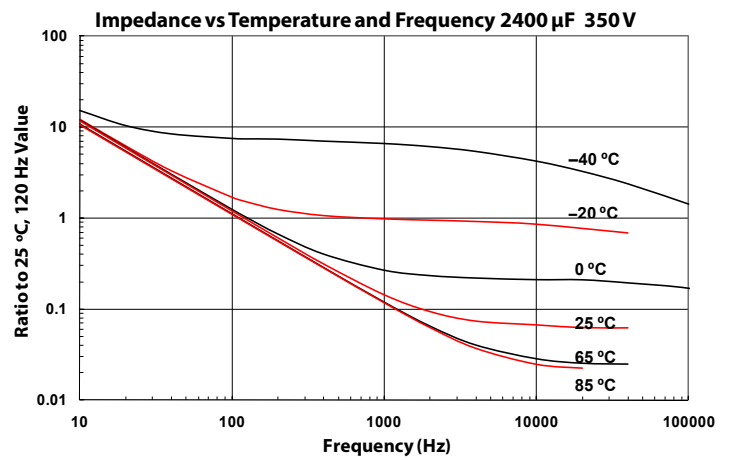
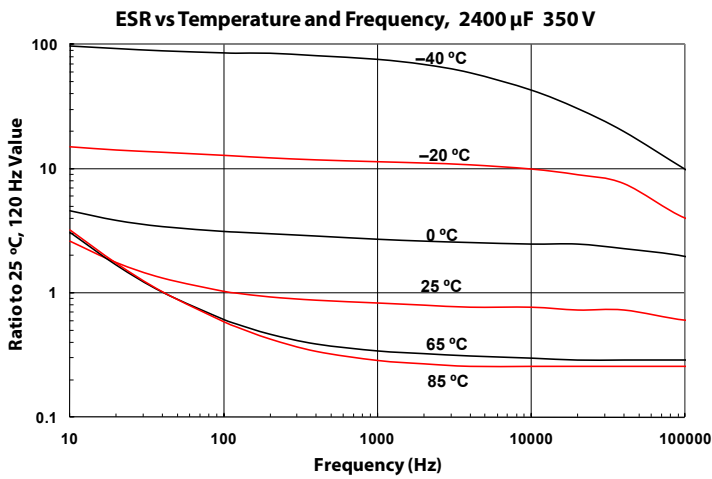
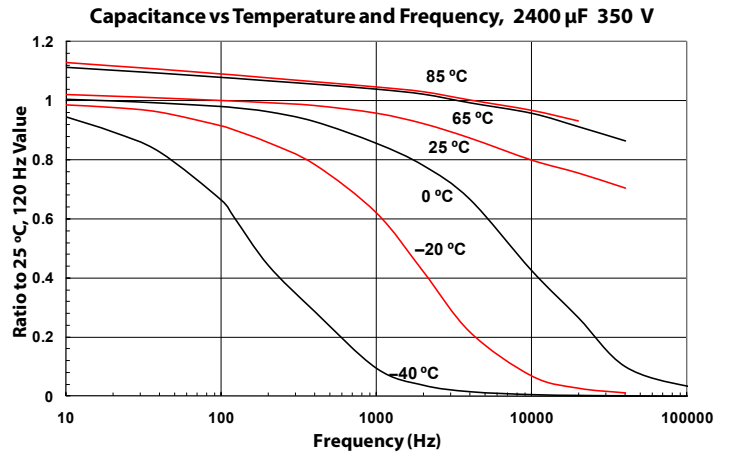
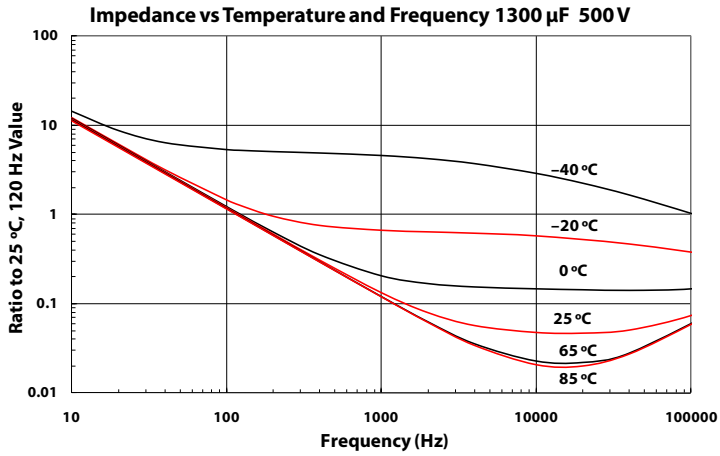

# Type DCMC 85 °C High Capacitance, Screw Terminal, Aluminum

## Highest Capacitance Screw Terminal Type

### Typical Performance Curves

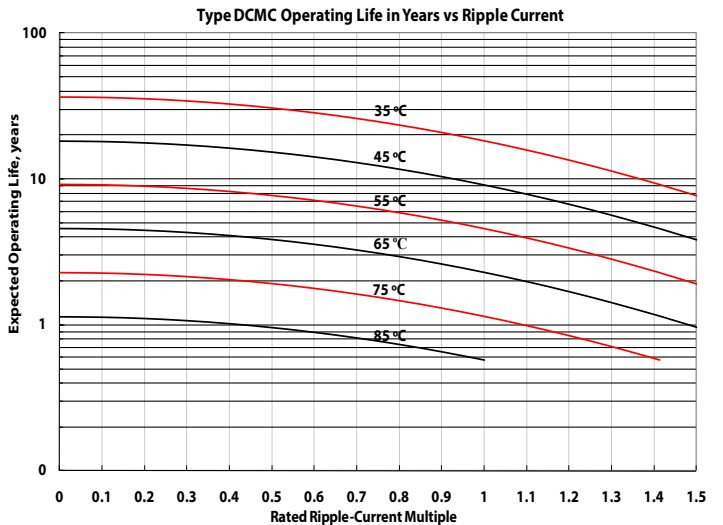
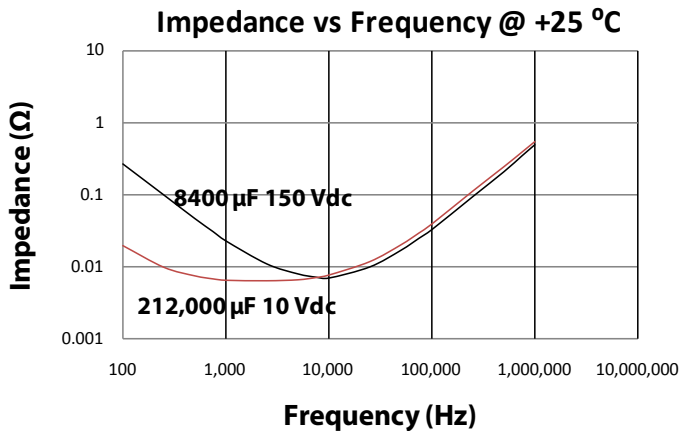
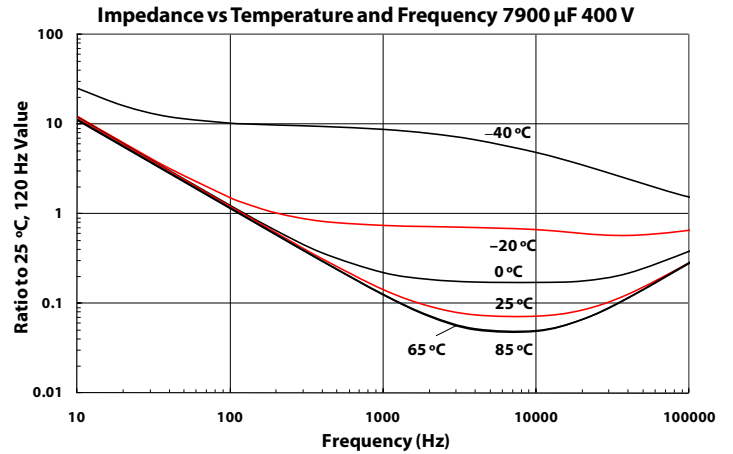
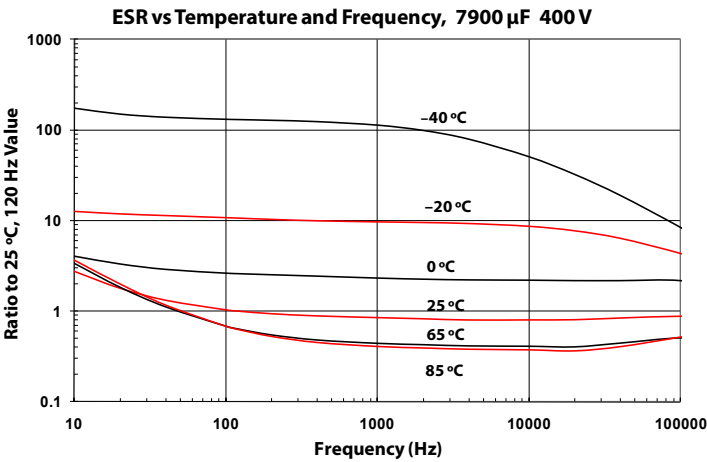
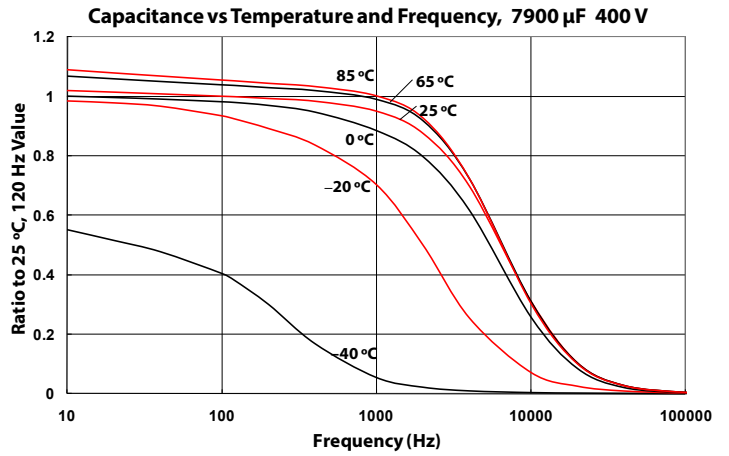
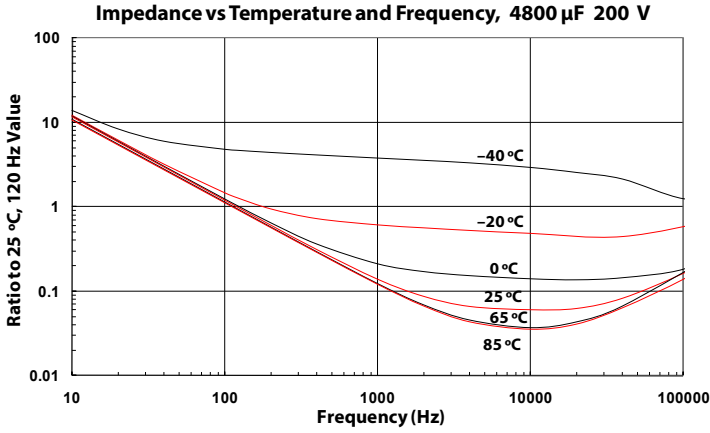

**Notice and Disclaimer:** All product drawings, descriptions, specifications, statements, information and data (collectively, the "Information") in this datasheet or other publication are subject to change. The customer is responsible for checking, confirming and verifying the extent to which the Information contained in this datasheet or other publication is applicable to an order at the time the order is placed. All Information given herein is believed to be accurate and reliable, but it is presented without any guarantee, warranty, representation or responsibility of any kind, expressed or implied. Statements of suitability for certain applications are based on the knowledge that the Cornell Dubilier company providing such statements ("Cornell Dubilier") has of operating conditions that such Cornell Dubilier company regards as typical for such applications, but are not intended to constitute any guarantee, warranty or representation regarding any such matter – and Cornell Dubilier specifically and expressly disclaims any guarantee, warranty or representation concerning the suitability for a specific customer application, use, storage, transportation, or operating environment. The Information is intended for use only by customers who have the requisite experience and capability to determine the correct products for their application. Any technical advice inferred from this Information or otherwise provided by Cornell Dubilier with reference to the use of any Cornell Dubilier products is given gratis (unless otherwise specified by Cornell Dubilier), and Cornell Dubilier assumes no obligation or liability for the advice given or results obtained. Although Cornell Dubilier strives to apply the most stringent quality and safety standards regarding the design and manufacturing of its products, in light of the current state of the art, isolated component failures may still occur. Accordingly, customer applications which require a high degree of reliability or safety should employ suitable designs or other safeguards (such as installation of protective circuitry or redundancies or other appropriate protective measures) in order to ensure that the failure of an electrical component does not result in a risk of personal injury or property damage. Although all product-related warnings, cautions and notes must be observed, the customer should not assume that all safety measures are indicated in such warnings, cautions and notes, or that other safety measures may not be required.